



Newland

SCANNING MADE SIMPLE



NFT10 Pilot Pro mobile computer user guide

Disclaimer

© 2020 Newland Auto-ID Tech. Co., Ltd. All rights reserved.

Please read through the manual carefully before using the product and operate it according to the manual. It is advised that you should keep this manual for future reference.

Do not disassemble the device or remove the seal label from the device, doing so will void the product warranty provided by Newland Auto-ID Tech. Co., Ltd.

All pictures in this manual are for reference only and actual product may differ. Regarding the product modification and update, Newland Auto-ID Tech. Co., Ltd. reserves the right to make changes to any software or hardware to improve reliability, function, or design at any time without notice. The information contained herein is subject to change without prior notice.

The products depicted in this manual may include software copyrighted by Newland Auto-ID Tech. Co., Ltd or third party. The user, corporation or individual, shall not duplicate, in whole or in part, distribute, modify, decompile, disassemble, decode, reverse engineer, rent, transfer or sublicense such software without prior written consent from the copyright holders.

This manual is copyrighted. No part of this publication may be reproduced, distributed, or used in any form without written permission from Newland.

Risk Warning Regarding Unauthorized System Updates:

You should use the Newland-provided tool to update this product's system. Modifying system files through installing a third-party ROM system or using any cracking method may result in product malfunction or data loss and this will void your warranty.

Newland Auto-ID Tech. Co., Ltd. reserves the right to make final interpretation of the statement above.

Newland Auto-ID Tech. Co., Ltd.

No.1, Rujiang West Rd., Mawei, Fuzhou, Fujian, China 350015

<http://www.newlandaidc.com>

Revision History

Version	Description	Date
V1.0	Initial Release.	2020-02-24
V1.1	Updated with Maintenance & Troubleshooting	2020-05-22

Contents

Chapter 1 About This Guide	1
Introduction.....	1
Documentation Set.....	1
Chapter Descriptions.....	1
More Information	2
Chapter 2 Getting Started	3
Introduction.....	3
Getting Started	3
The NFT10.....	3
Charging the Battery	5
On-screen Buttons	6
Installing SIM Card/TF Card.....	8
Chapter 3 Basics.....	9
Introduction.....	9
Switching On/Rebooting/Switching Off the NFT10.....	9
Locking/Unlocking the NFT10	10
Home Screen	12
Status Icons.....	13
Installing App.....	14
Uninstalling App.....	14
Date & Time.....	15
Display.....	16
Ringtones	16
Restoring Factory Settings	17
Language & Input Method	18
Floating Button Settings	19
Shortcuts to Apps	20
Widgets	20
Chapter 4 Scanning Barcodes.....	21
Introduction.....	21
Scanning 1D Barcode	21
Scanning 2D Barcode	22
Programming Scanner	23
Enable Scan	23
Output Mode.....	24

Scan Mode	25
Scan Trigger	26
Prefix & Suffix	26
Good Read Indicator	27
Encoding	27
Data Edit.....	28
Broadcast-output Settings	29
Symbologies	29
Chapter 5 Bluetooth	31
Chapter 6 Wi-Fi	33
Introduction.....	33
Wi-Fi Settings	33
IP Settings	34
Chapter 7 Mobile Network.....	35
Introduction.....	35
Mobile Network Settings.....	35
APN Settings	36
Chapter 8 Others.....	38
Camera.....	38
GPS	39
NFC	40
Key Map	41
Chapter 9 Admin Tool.....	43
Introduction.....	43
Launching the Admin Tool	43
Switching between User Mode and Admin Mode.....	45
Chapter 10 Whitelist Manager	46
Introduction.....	46
Logging in to Whitelist Manager	46
Chapter 11 System Update	47
Introduction.....	47
Online Update	47
Local Update	47
Chapter 12 App Development Guide.....	51
Development Environment	51
Use of Non-standard Interfaces	51

Chapter 13 Maintenance & Troubleshooting.....	52
Introduction.....	52
Important Safety & Handling Information	52
Disassembly and Retrofit	52
External Power Supply.....	52
Abnormal Situation.....	52
Drop Damage.....	52
LCD Screen.....	52
Stacking Heavy Objects	52
Mounting Location.....	52
Wireless Functionalities	53
Use & Maintenance.....	53
Troubleshooting.....	54

Chapter 1 About This Guide

Introduction

This guide provides instructions for programming and operating the NLS-NFT10 portable data collector (hereinafter referred to as “the NFT10” or “the terminal”).

Documentation Set

The documentation set for the **NFT10** includes:

- ✧ **NLS-NFT10 Portable Data Collector Quick Start:** Describes how to get the NLS-NFT10 up and running.
- ✧ **NLS-NFT10 Portable Data Collector User Guide:** Describes how to program and use the NLS-NFT10.

Chapter Descriptions

- ✧ *Chapter 1 About This Guide* Provides a general description of this manual.
- ✧ *Chapter 2 Getting Started* Provides information on getting the NFT10 up and running for the first time.
- ✧ *Chapter 3 Basics* Describes how to program the NFT10 for the use of its basic features.
- ✧ *Chapter 4 Scanning Barcodes* Provides the instructions as to how to scan 1D/2D barcodes and how to program the scanner.
- ✧ *Chapter 5 Bluetooth* Explains how to use Bluetooth functionality.
- ✧ *Chapter 6 Wi-Fi* Explains how to use Wi-Fi functionality.
- ✧ *Chapter 7 Mobile Network* Explains how to use Mobile Network functionality.
- ✧ *Chapter 8 Others* Explains how to use Camera, GPS, and NFC functionalities.
- ✧ *Chapter 9 Admin Tool* Explains how to use the admin tool.
- ✧ *Chapter 10 Whitelist Manager* Explains how to use the whitelist management tool.
- ✧ *Chapter 11 System Update* Explains how to update the system.

✧ *Chapter 12 App Development Guide*

Describes the app development environment and the use of non-standard interfaces.

✧ *Chapter 13 Maintenance & Troubleshooting*

Provides troubleshooting solutions for issues that might occur when using the NFT10.

More Information

For more product and support information, please visit our web site: <http://www.newlandaidc.com>.

Chapter 2 Getting Started

Introduction

This chapter lists the parts for the NFT10 and explains how to charge the battery and power on the NFT10 for the first time.

Getting Started

The NFT10

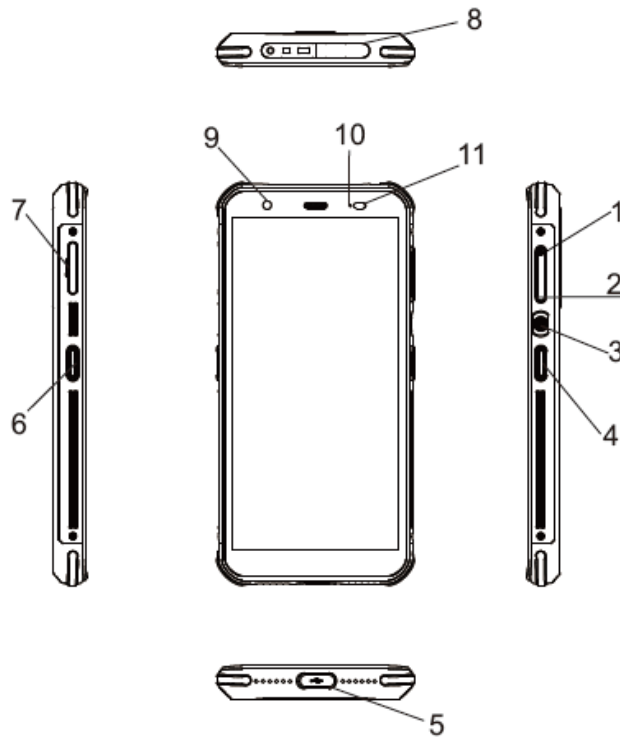

1	Volume+	2	Volume-
3	Power Key	4	Right Scan Key
5	USB Port	6	Left Scan Key
7	SIM/TF Card Slot	8	Scanning Window

9 Front Camera

10 LEDs

11 Light/Proximity Sensors

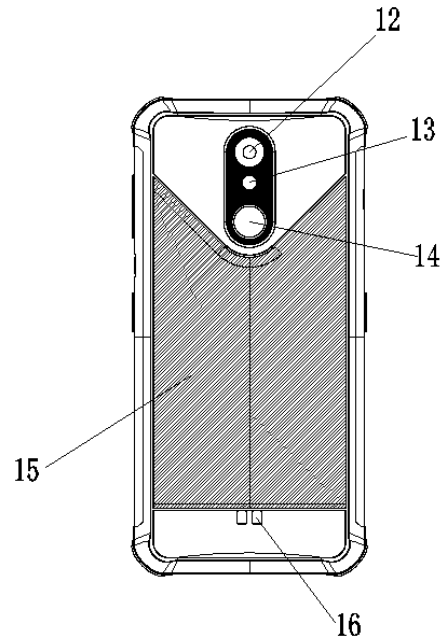

12 Rear Camera

13 Flashlight

14 Fingerprint Recognition

15 NFC Detection Area

16 Charging Contact

Charging the Battery

Connect the NFT10 to a power outlet using the included AC adapter or USB cable. When the terminal's battery is less than 5%, it takes about 3 hours to fully charge it (The terminal is shut down or in sleep mode).

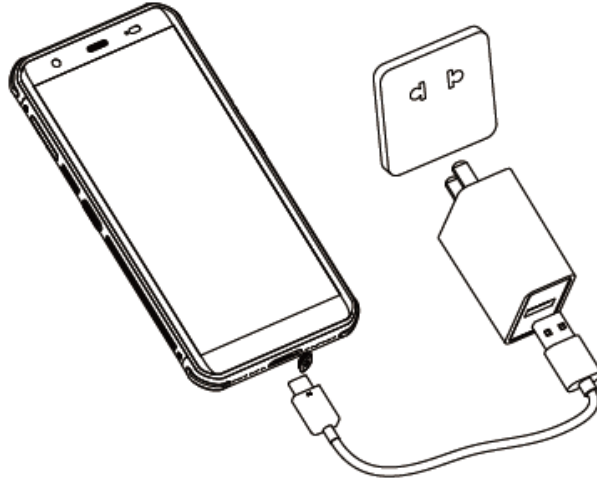

When charging the NFT10 with an AC adapter or USB cable, the user is notified of the charging statuses by the LEDs on the terminal.

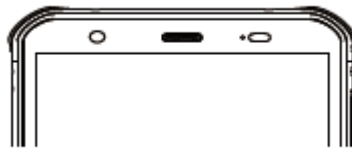

LEDs on the NFT10	
Green LED on	Fully charged
Red LED on	Charging in progress
Red LED flashes constantly	Low-battery alert

Note: If the NFT10 battery is completely drained, please press the power key to turn on after 15 minutes of being charged.

On-screen Buttons



1	Return Button	2	Home Button
3	Overview Button		

The NFT10 has five physical keys and three on-screen buttons. The on-screen buttons include Back Button, Home Button, and Overview Button.

Return Button: Tap it to go back to the previous screen.

Home Button: Tap it to go back to the home screen.

Overview Button: Tap it to display a list of thumbnail images of apps you've worked with recently. To open an app, tap it. To remove a thumbnail from the list, swipe it left or right.

Communicating with PC

Step 1: Connect the Micro USB port on the NFT10 to your computer with the included USB cable.

Step 2: Switch NFT10 on. On the home screen, swipe from top to open the notification bar.

Step 3: Tap “Tap for more options”.

Step 4: Select “Transfer Files”. Navigate to the “My Computer” section of your computer and look for the newly added drive. Double-click it and you will be connected to the NFT10. Then you may handle the files on the terminal through your computer.

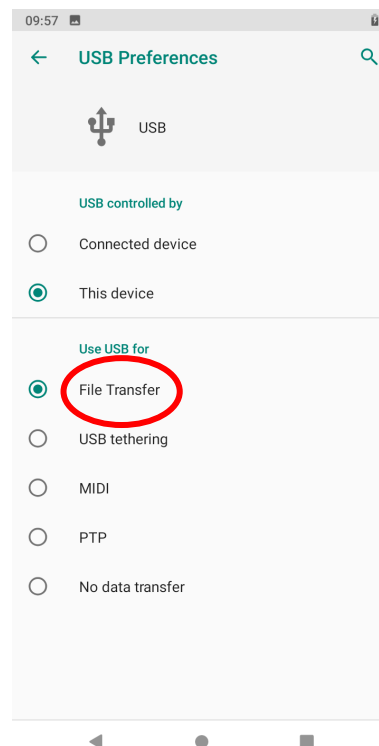
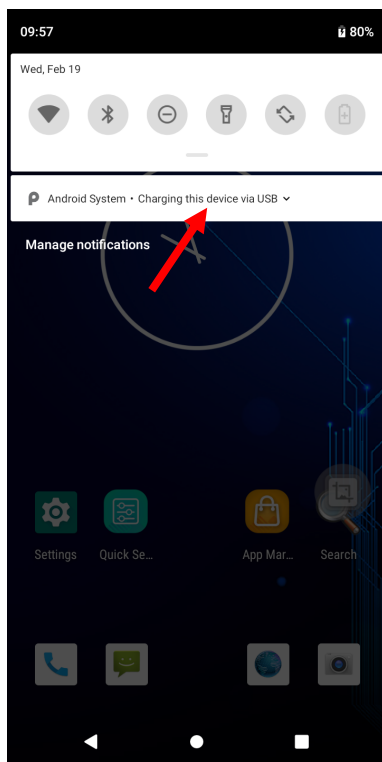

Installing SIM Card/TF Card

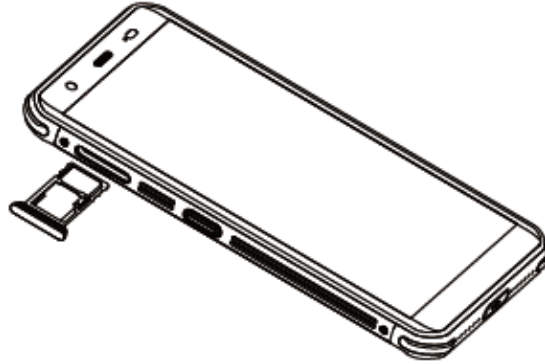

Step 1: Pull the SIM/TF card tray out from the slot on the left side of the terminal.

Step 2: Place the SIM/TF card into the tray and then gently push the tray all the way into the slot until it locks in place.

Chapter 3 Basics

Introduction

This chapter provides the basics of setting and using the NFT10

Switching On/Rebooting/Switching Off the NFT10

After installed with the SIM card and fully charged, you can start to use the NFT10.

Switch the NFT10 on: Hold down the Power key on the right side of the terminal until the Android logo is displayed. Note that the initialization is going to take some time before the NFT10 displays the Home screen.

Reboot the NFT10: Hold down the Power key on the right side of the terminal until the window below pops up, then tap “Restart”.

Switch the NFT10 off: Hold down the Power key on the right side of the terminal until the window below pops up, then tap “Power off”.

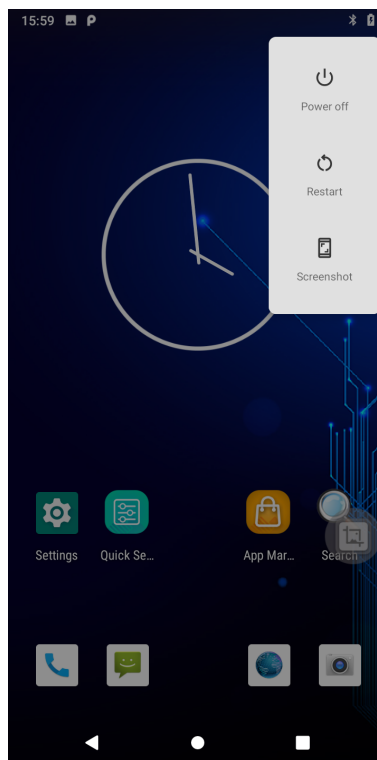

Locking/Unlocking the NFT10

Lock the NFT10: Briefly press the Power key on the right side of the terminal. If no operation is performed on the NFT10 for a preset period, the NFT10 locks automatically. You can change how long it takes for the NFT10 to lock.

Unlock the NFT10: Briefly press the Power key on the right side of the terminal and swipe up from the bottom of the

screen to unlock. Tap the app icon  and then “Security & location” -> “Screen lock” and set the unlock sequence per your needs.

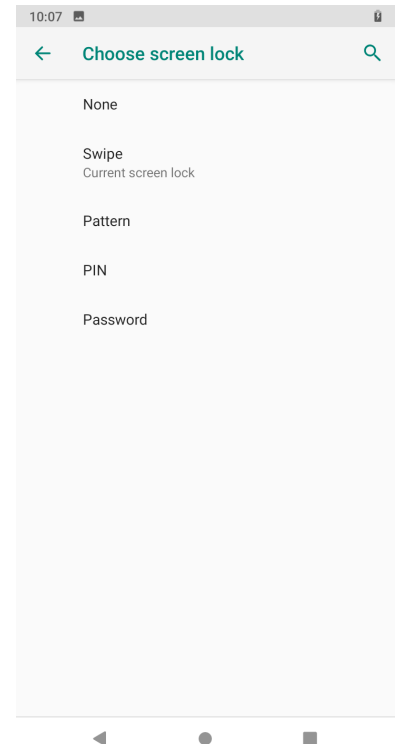
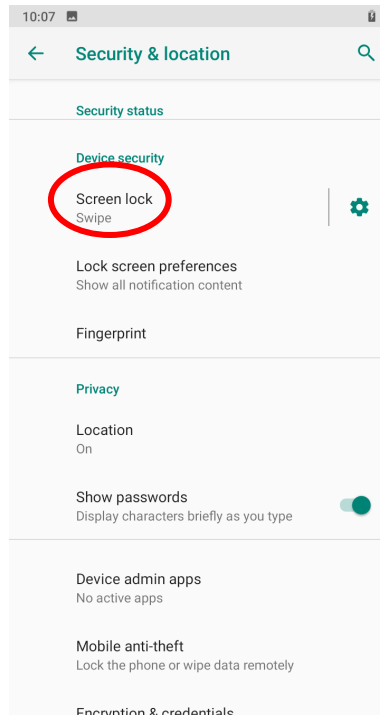
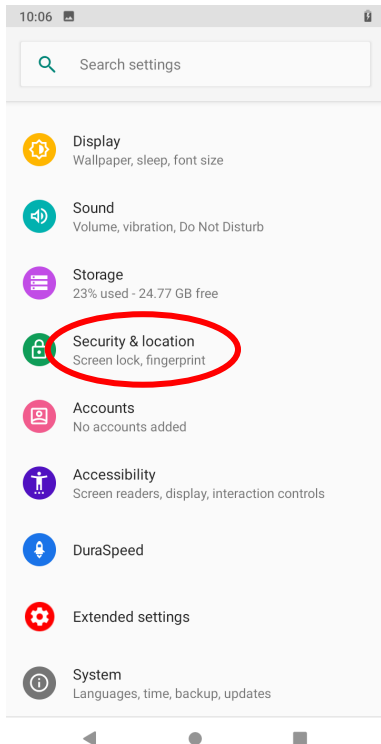



Unlock with Fingerprint: Tap the app icon  and then “Security & location” -> “Fingerprint” and follow the fingerprint instructions on the screen to finish the steps.

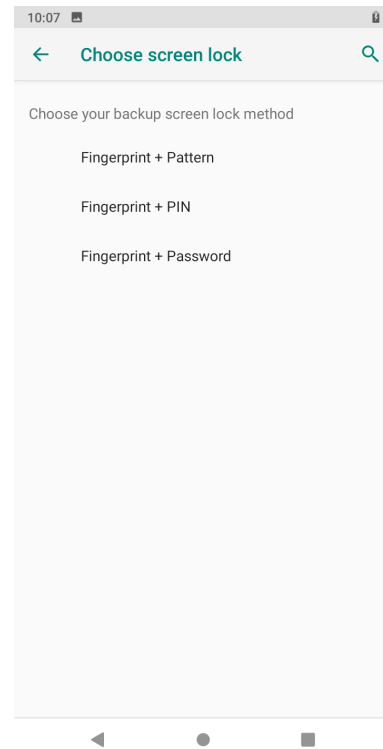
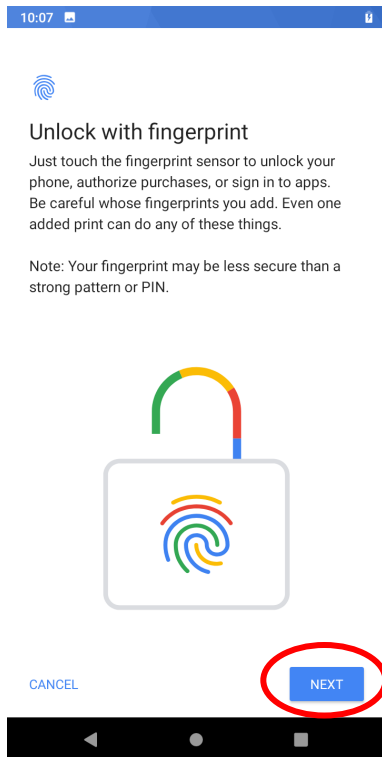
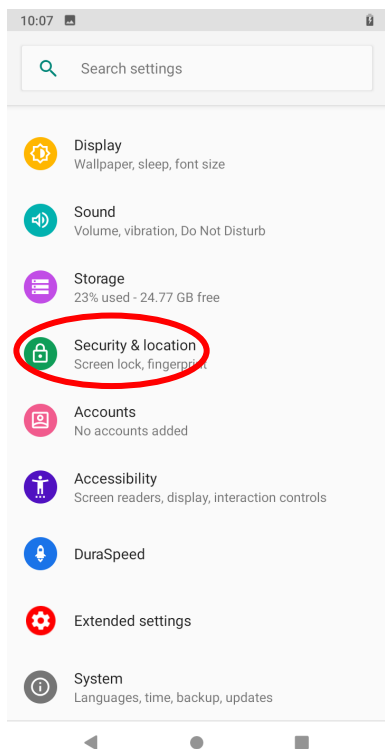

Home Screen

View another Home screen: Swipe left or right.

Go to the Home screen: Tap the Home key.

Open an app: Tap it.

View all apps/Open apps list: Swipe up from the bottom of the screen to view all the apps.

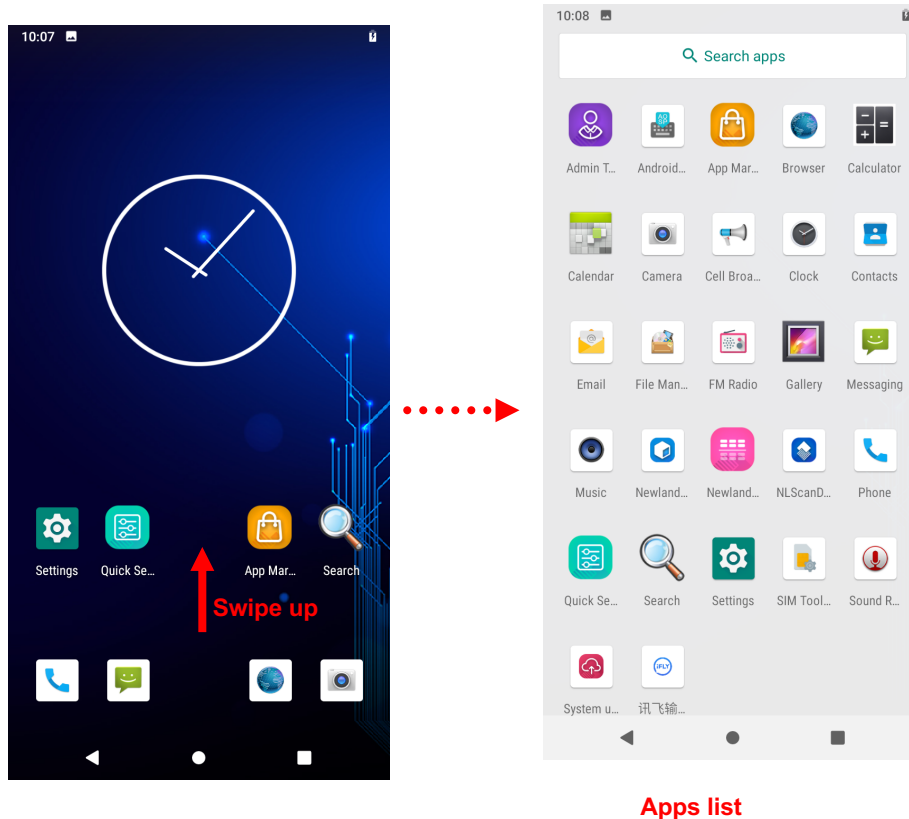











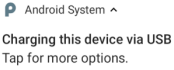
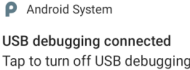

Add an app icon to the Home screen: Swipe up from the bottom of the screen to view all the apps. Tap and hold your desired app until it appears on the Home screen and then drag it into a blank area.

Delete an app icon on the Home screen: Tap and hold your desired app on the Home screen until “X Remove” appears, then drag the app into it. Note that this operation only removes the icon from the Home screen. To remove the app from the NFT10, see the **Uninstalling App** section.

Status Icons

The icons in the notification bar at the top of the screen give information about the NFT10.

Status Icon	Description	Status Icon	Description
	WLAN on		Signal Strength
	Bluetooth on		Airplane Mode on
	USB Connected		USB Debugging
	Missed Calls		Battery Charging in Progress
	New Message		Hotspot & Tethering
	Positioning		Power Saving Mode
	Don't Disturb Mode		Vibrate on

Installing App

Use one of the following methods to install a new app on the NFT10:

1. Download an APK file from the online app store and install it.
2. Download software package onto a MicroSD card or PC and copy it to your terminal. Then install it with File Manager.
3. Install a new app using a mobile assistant (such as Baidu Mobile Assistant) installed on the PC.

Uninstalling App

Follow the procedure below to remove an app from the NFT10:

Swipe Home screen from bottom to top with one finger in one smooth motion to view all the app. Tap and hold your desired app until “App info” appears, then tap “UNINSTALL” and uninstall it

*The application that comes with the system cannot be uninstalled.

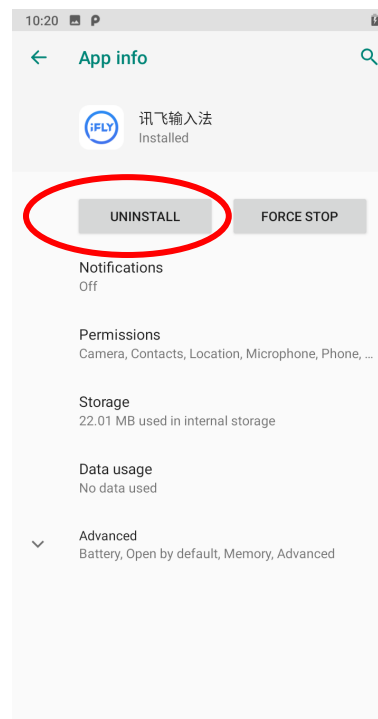
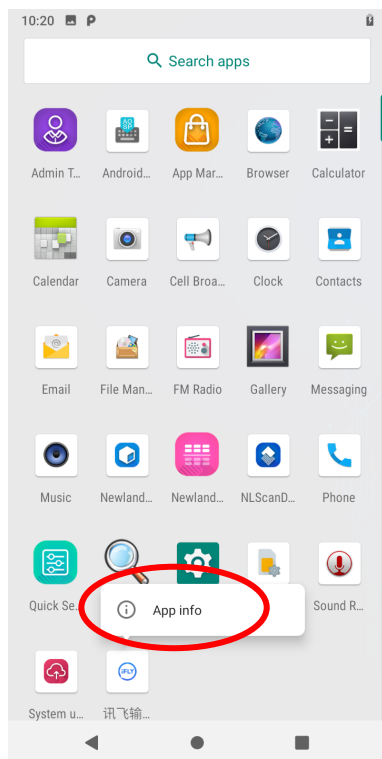

Date & Time

Set the date and time: Tap the app icon  and then “System” -> “Date & time” and set the date and time on the screen shown below as per your needs.

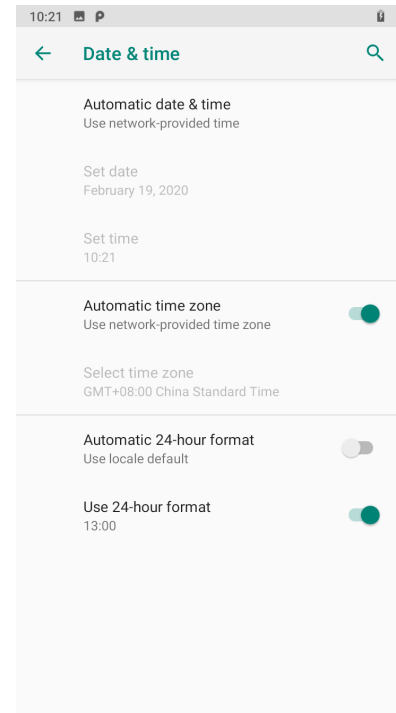
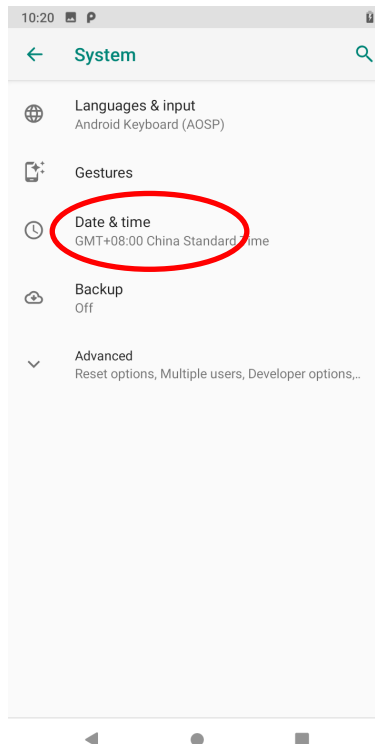
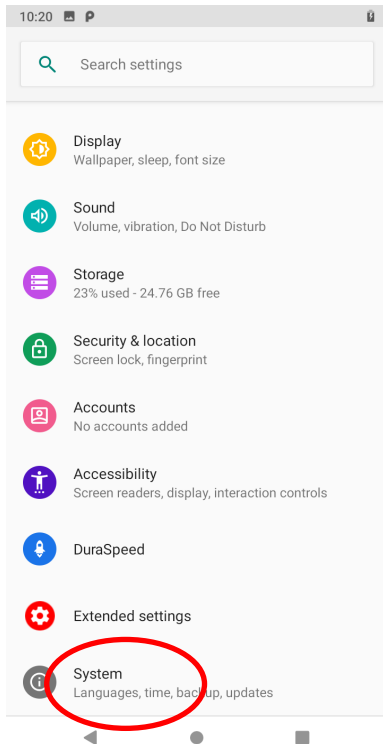

Display

Tap the app icon  and then “Display”, and set the brightness level, night light, adaptive brightness, wallpaper, and other parameters on the screen shown below as per your needs.

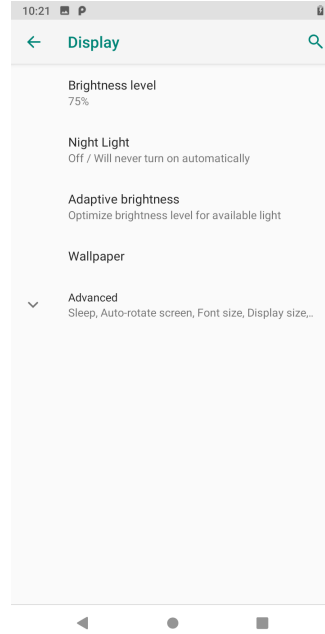
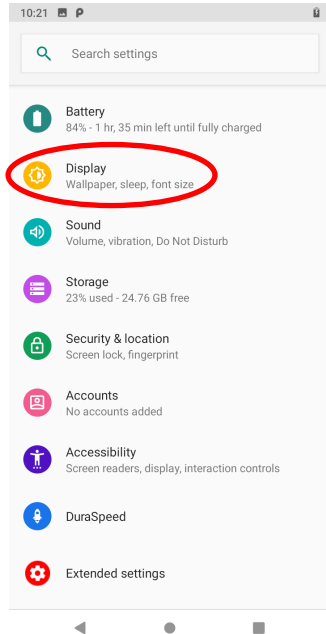

Ringtones

Tap the app icon  -> “Sound”. Then set the ringtones and other notification sounds as per your needs.

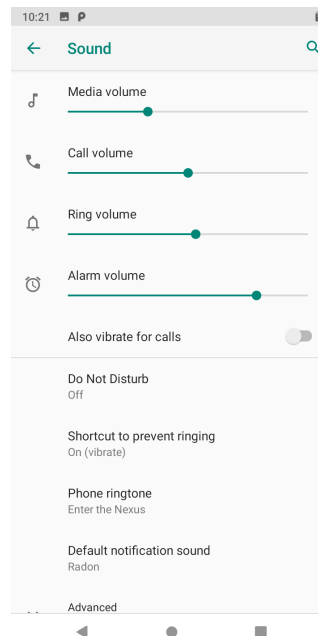
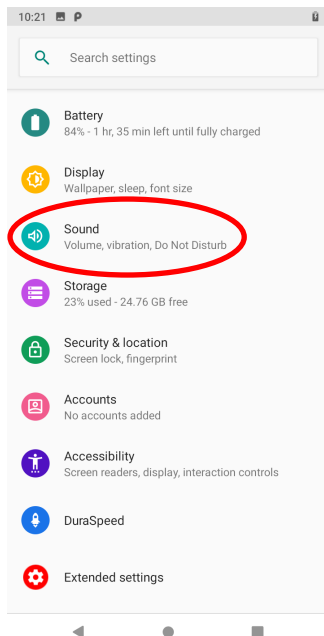

Restoring Factory Settings

Tap the app icon  -> "System" -> "Advanced" -> "Reset options" -> "Erase all data (factory reset)" -> "Reset Phone" -> "ERASE EVERYTHING".

After this operation, the terminal will be reset to factory defaults and all the personal data on the internal storage, such as music and photos, will be deleted.

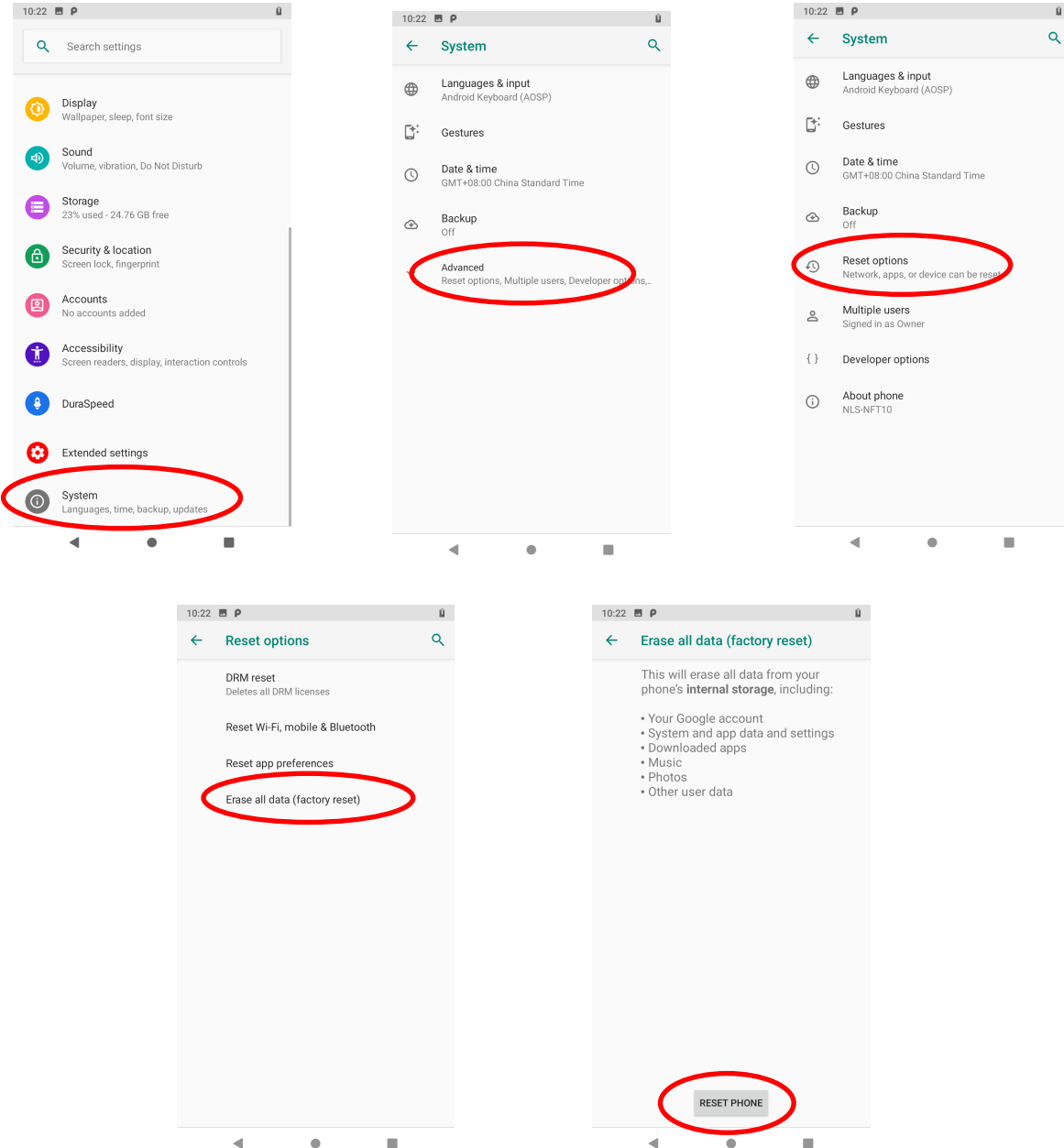

Language & Input Method

Tap the app icon  -> "System"-> "Languages & input". Then set the language and input method as per your needs.

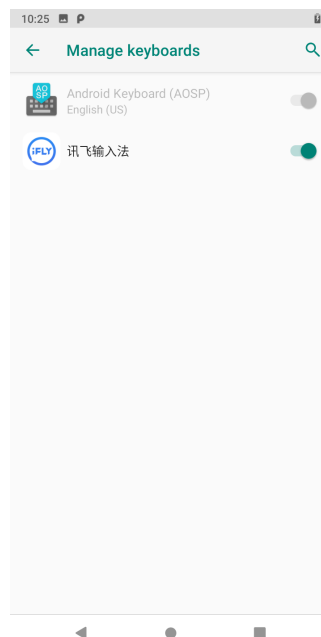
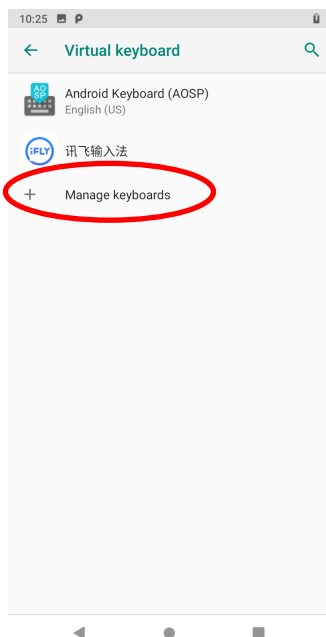
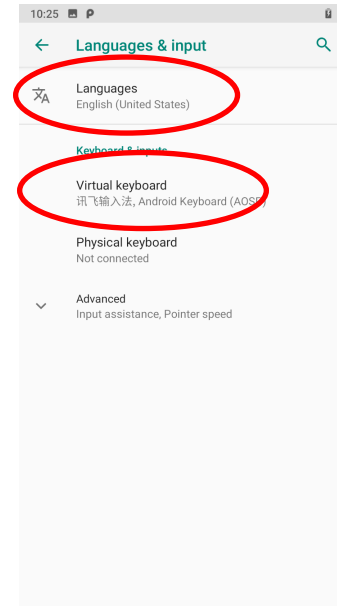
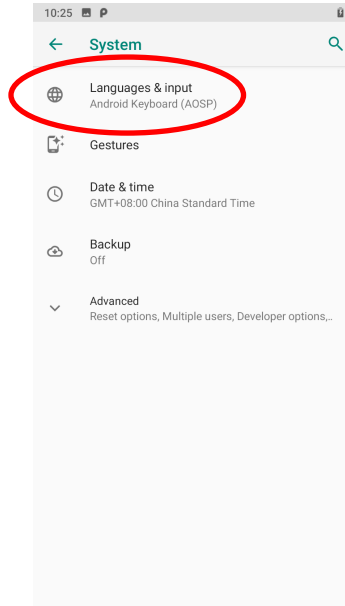
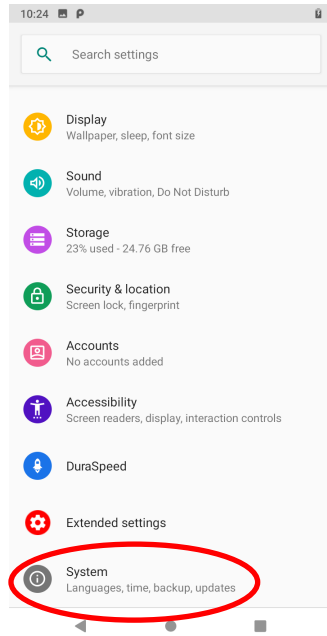

Floating Button Settings

Tapping the floating button can perform tasks such as scanning barcode (**Scan**), turning on/off flashlight (**Flashlight**), taking a screenshot (**Screen snapshot**), turning off screen (**Screen off**), going to the Home screen (**Home**), or switching between level and continue scan mode(**Toggle level and continue scan mode**).

Holding down the floating button  can make it movable.

Show/Hide the floating button: Tap the app icon  -> “Extend Settings”-> “Float settings”-> select/unselect “Show float box”.

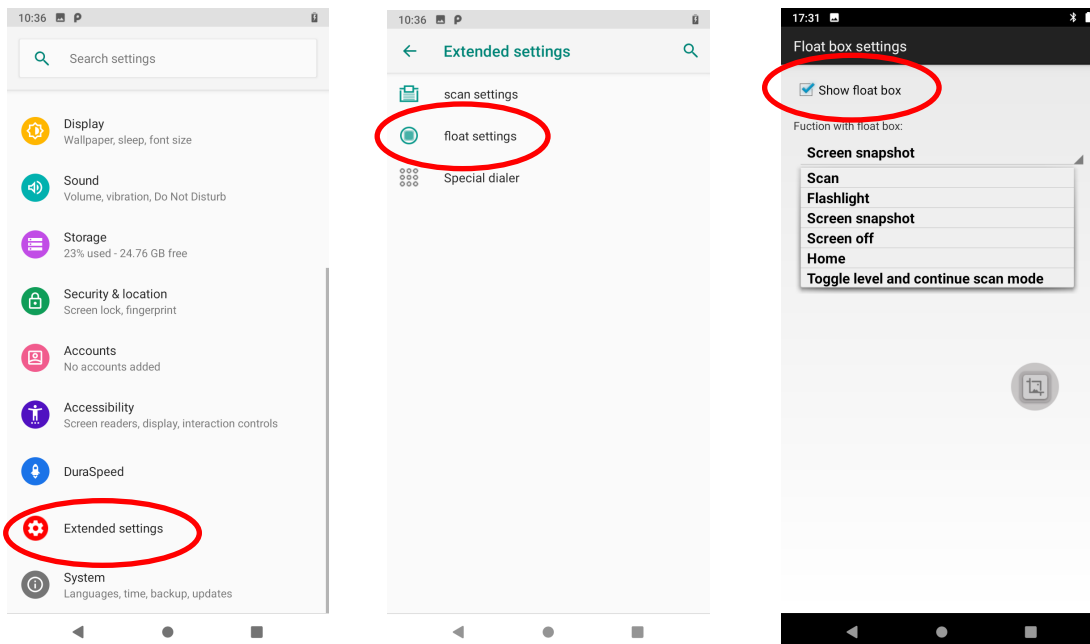

Shortcuts to Apps

Create a shortcut to an app on your Home screen: On the home screen, swipe up from the bottom to top with one finger in one smooth motion to view all apps. Tap and hold your desired app and then drag it into the Home screen.

Widgets

View all widgets: Tap and hold on a blank area of the Home screen and then tap.



Open a widget: Tap it.

Add a widget icon to the Home screen: Tap and hold the Home screen and then tap . Tap and hold your desired widget and then drag it into the Home screen.

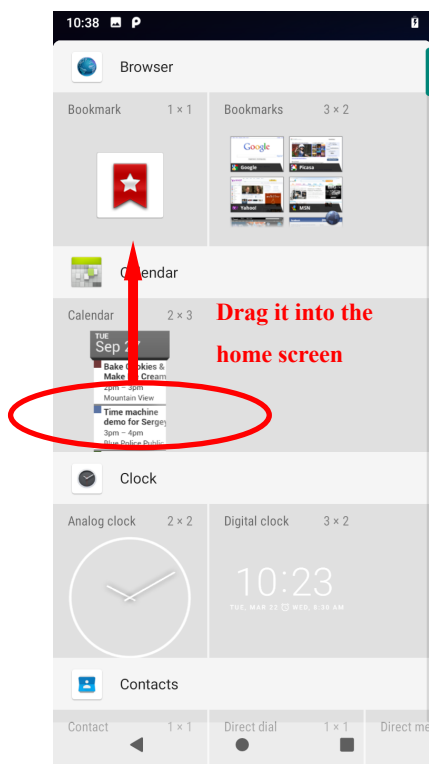
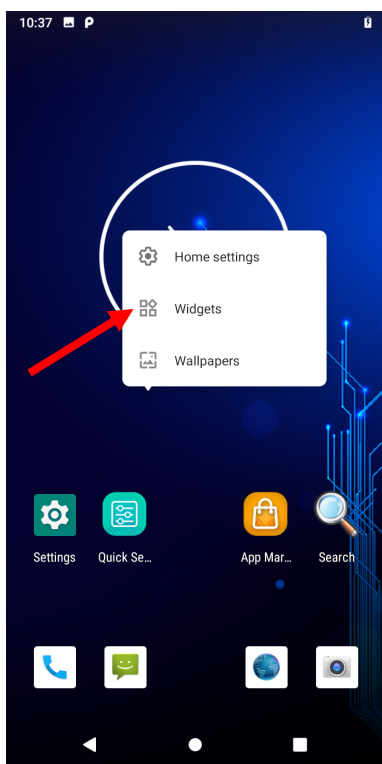

Chapter 4 Scanning Barcodes

Introduction

This chapter includes scanning tips and instructions for setting up the scanner.

Scanning 1D Barcode

Adjust the scan angle or the distance between the NFT10 and the target barcode to ensure the length of the laser beam is roughly 8mm greater than that of the barcode, as shown below.



Correct	Wrong

Scanning 2D Barcode

Adjust the scan angle and the distance between the NFT10 and the target barcode to make them fall into the following ranges:

1. Point the NFT10's focus lamp at the center of the barcode.
2. Move the NFT10 until you find the appropriate scan distance.
3. Optimum scan angles:



Skew (α) < 45° (0° preferably)

Pitch (γ) < 45° (5°- 20°preferably)

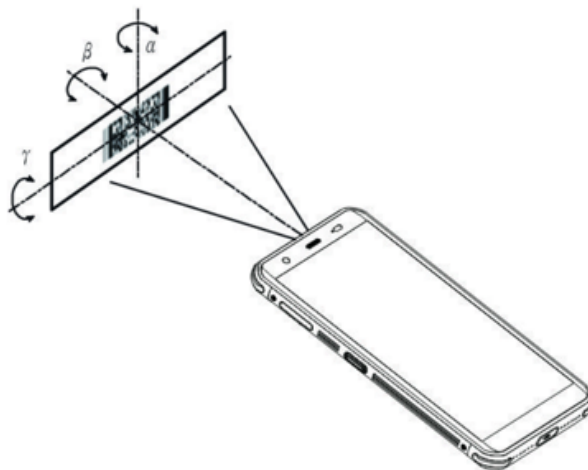
Roll (β) = 0°- 360°



Programming Scanner

Tap the app icon  -> "Extend Settings" -> "Scan Settings". Alternatively, tap the app icon  on the Home screen

 -> Scan Setting. Then configure the scanner parameters as per your actual needs.

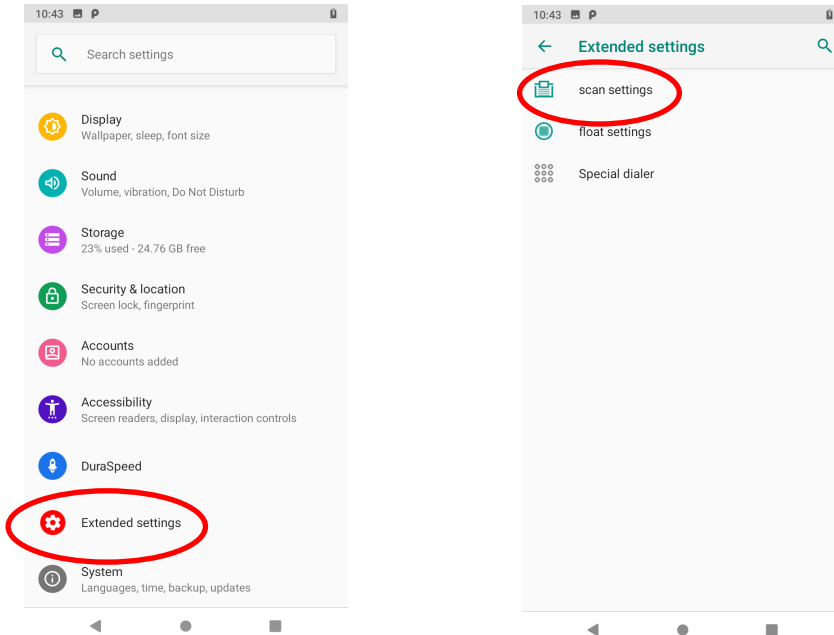

Enable Scan

Check or uncheck the "Enable scan" item to enable or disable the scanning feature of the NFT10.

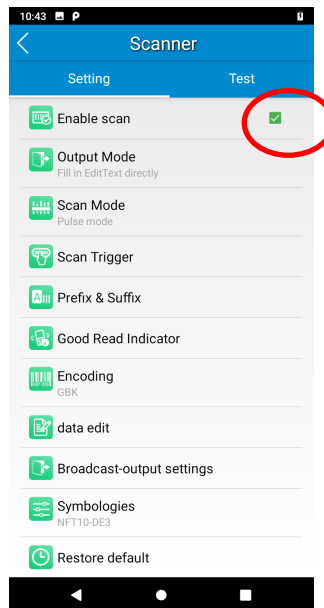

Output Mode

The NFT10 provides three output modes: Simulate keystroke, Output via API, and Fill in EditText directly.

1. **Simulate keystroke:** Output scanned data to keyboard buffer to simulate keyboard input.

Character interval (ms): A character interval of 0-100 milliseconds may be placed between the transmissions of each character of scanned data.

2. **Output via API:** Application acquires scanned data by receiving system broadcasts.

3. **Fill in EditText directly:** Output scanned data at the current cursor position in EditText.

Overwrite output: Clear the text input box before sending the barcode currently scanned to make sure only the most recently scanned data is present in the text input box. This feature is available only when **Simulate keystroke** or **Fill in EditText directly** is selected.

Output enter-event: Send an Enter Key after each barcode scanned.

Send virtual keyboard function: Make send virtual keyboard function as “action done”, “action search”, “action previous”, action search, etc.

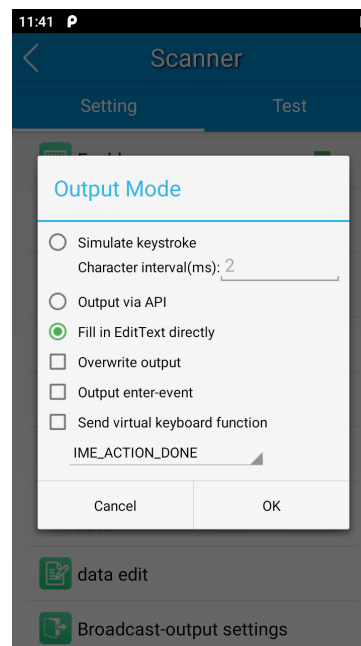
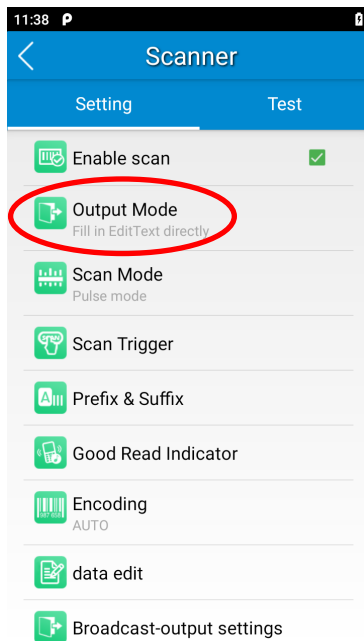

Scan Mode

The NFT10 provides the following four scan modes:

1. **Level mode:** Press and hold the scan trigger to start a decode session which continues until the trigger is released.
2. **Continuous mode:** Press the scan trigger to continuously read barcodes. To suspend or resume scan operation, simply press the scan trigger.

Scan interval (ms): This parameter sets the timeout between decode sessions.

3. **Pulse mode:** Press the scan trigger to start a decode session which continues until the decode session timeout expires.
4. **Delay mode (Scan on release key):** Press and hold the scan trigger to aim at barcode then release it to start a decode session which continues until the decode session timeout expires or a barcode is decoded. It is advised to use this scan mode and the **Acuscan Decoding** feature to ensure that only the desired barcodes are read if multiple barcodes are placed closely together.

Decode session timeout (ms): This parameter sets the maximum time decode session continues during a scan attempt.

Masked repeat interval (ms): This parameter sets the time interval between two successive reads on the same barcode.

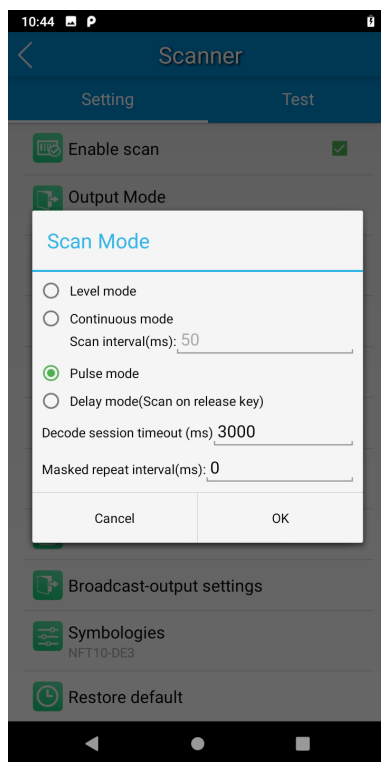
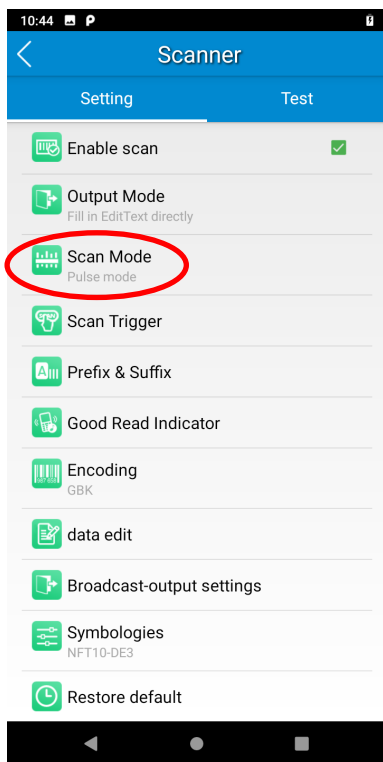

Scan Trigger

Left/Right SCAN key: Use the Scan key on the left/right side of the terminal as a scan trigger. Enable or disable them as per your actual needs.

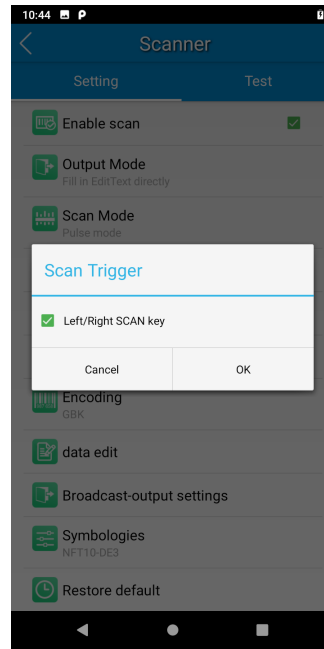
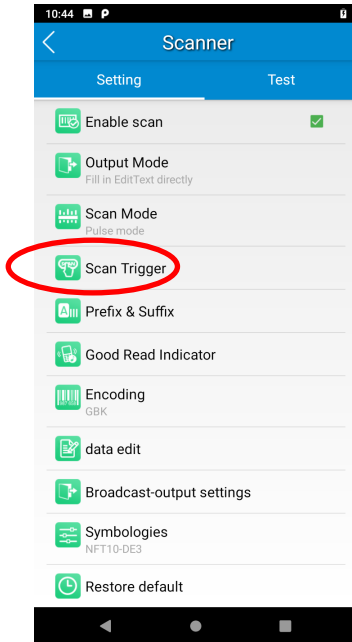

Prefix & Suffix

To set the prefix/suffix, enter the hexadecimal value of a desired prefix/suffix, and then tap "OK". For example, if you want to add a Line Feed character after each barcode, set the suffix to "0A"; if you want to add a Carriage Return character after each barcode, set the suffix to "0D".

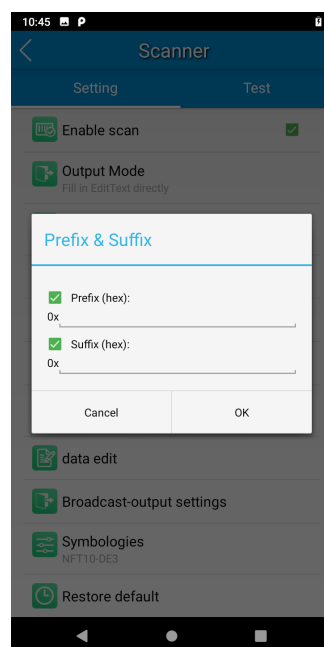
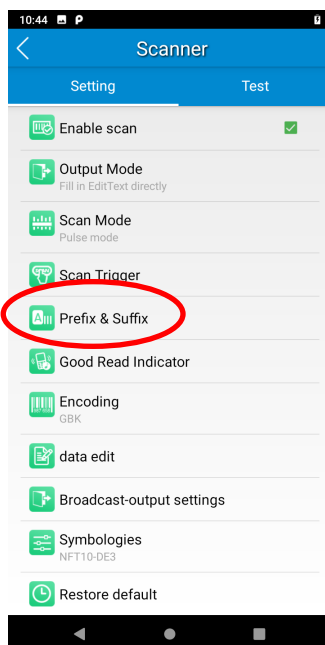

Good Read Indicator

The terminal can use sound/ vibration/ LED to indicate a good read. Choose one or more options as per your actual needs.

1. **Sound:** The NFT10 issues a short beep to indicate a good read.
2. **Vibrating:** The NFT10 vibrates to indicate a good read.
3. **LED:** The blue LED on the NFT10 flashes once to indicate a good read.

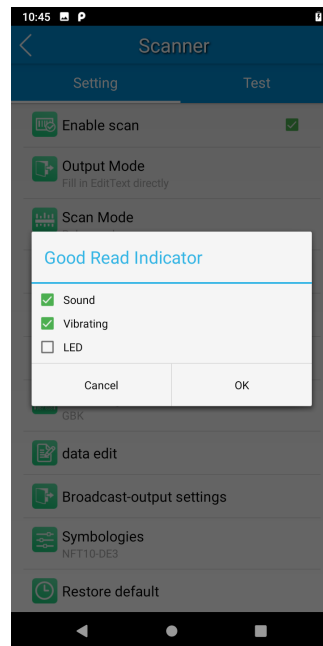
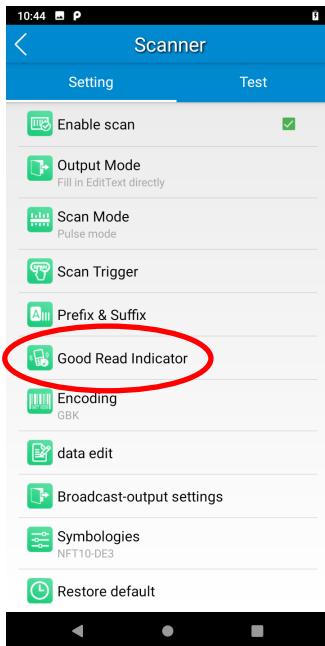

Encoding

Choose a character encoding to interpret barcode data.

1. **AUTO:** The terminal determines automatically if the target barcode uses UTF-8, GBK, or ISO-8859-1 encoding. If the terminal produces the wrong output, you may need to choose or enter a specific character encoding.
2. **UTF-8:** Dominant Unicode encoding.
3. **GBK:** A character encoding for Chinese characters.
4. **ISO-8859-1:** A common character encoding that covers Western European languages.
5. **windows-1251:** A character encoding designed to cover language that uses the Cyrillic alphabet such as Russian, Bulgarian, Serbian Cyrillic, and other languages.
6. **Other:** Enter a different character encoding when UTF-8, GBK, ISO-8859-1, and windows-1251 are not applicable. If the terminal does not support the encoding entered, this setting will fail.

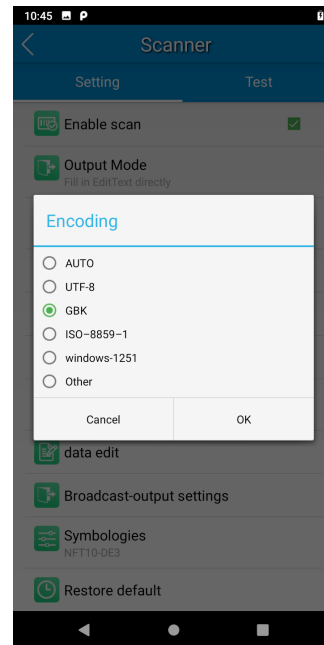
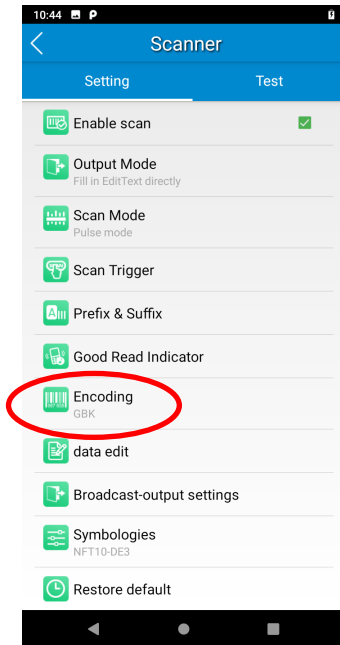

Data Edit

This feature allows you to edit barcode data with a script.

Tap “load script” and then select the desired script file on the terminal, or scan the 2D barcode that contains a script, to load the script. Then select “exec script” and tap “OK”.

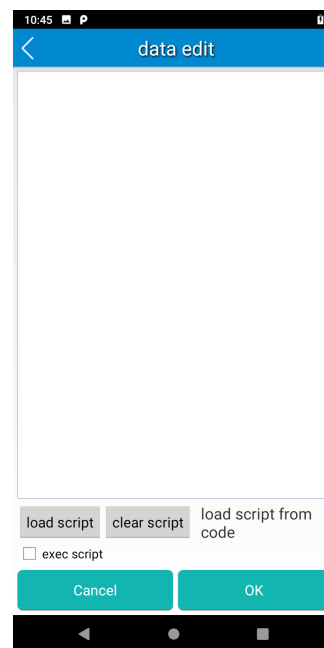
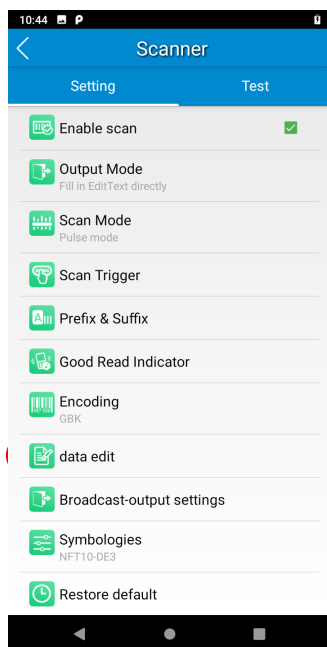

Broadcast-output Settings

When using broadcast as the scan output method, the NFT10 will output the scan information with the specified broadcast ACTION and EXTRA.

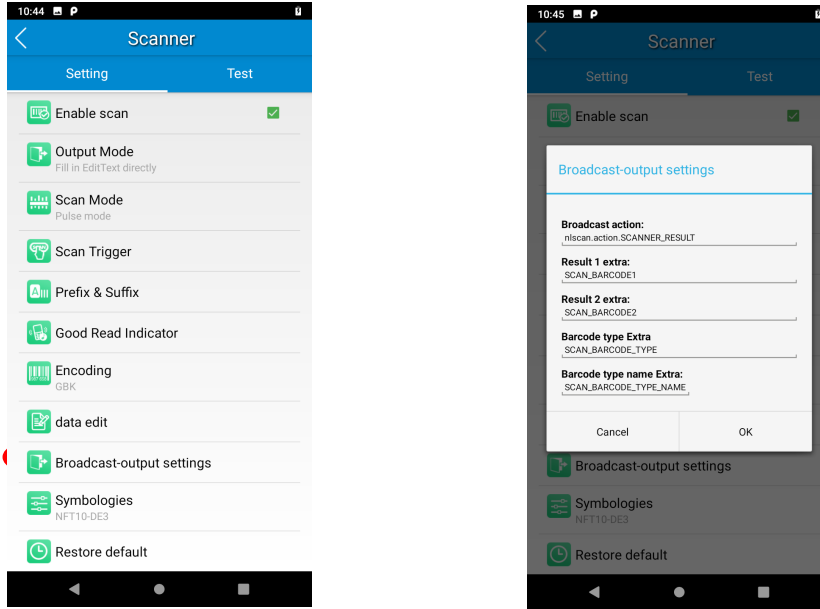

Symbologies

Note that supported symbologies depend on the scan engine integrated in the terminal. Here we will take DE3 for example.

1D code: Enable or disable 1D symbologies and set other barcode parameters.

2D code: Enable or disable 2D symbologies and set other barcode parameters.

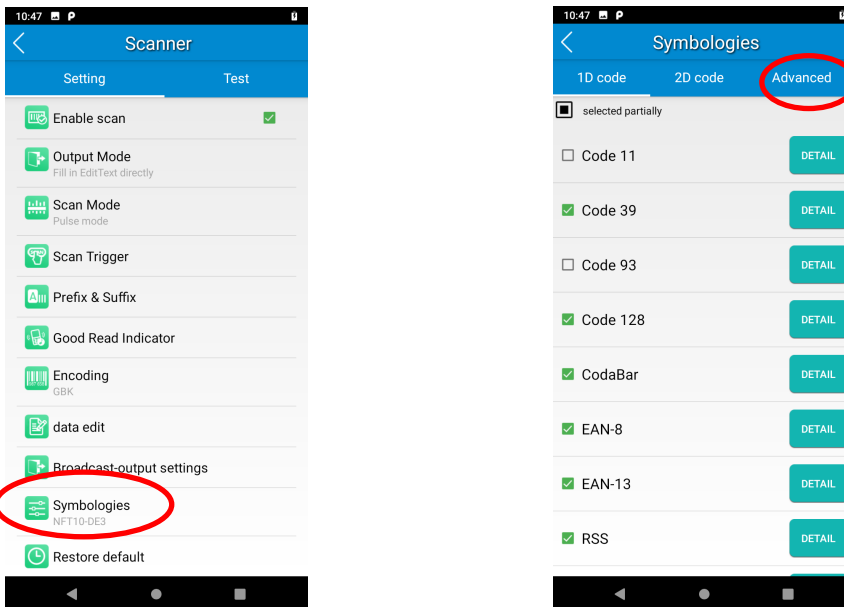

Advanced: The features listed here are designed to improve the scanning performance and energy efficiency of the terminal.

1. **Acuscan Decoding:** When selected, the terminal only decodes the barcode aimed squarely by the aiming pattern. It is advised to select it to ensure that only the desired barcodes are read if multiple barcodes are placed closely together.
2. **Other:** Tap **DETAIL** to access the following parameter settings.

Noise Reduction: This feature is designed to reduce noise in images produced by the terminal. However, the terminal shows a slight decrease in scanning speed when using this feature. It is recommended to enable it only when necessary.

Exposure Level: Select Auto adaptive or Illuminate off per actual need.

Power Plan: Two options are provided.

Power Saving: The terminal's built-in scanner turns off automatically after 3 seconds of inactivity.

High-performance: The terminal's built-in scanner turns off automatically after 15 seconds of inactivity.

OCR Enable: Select this check box when reading passports (compliant with ICAODoc9303 standards, TD1/TD2/TD3 supported).

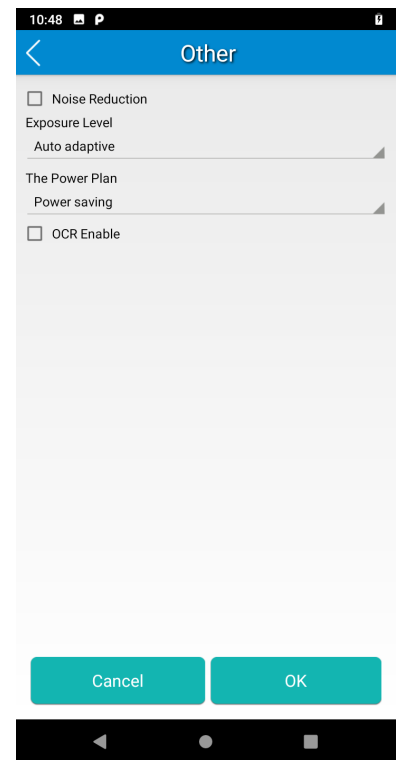
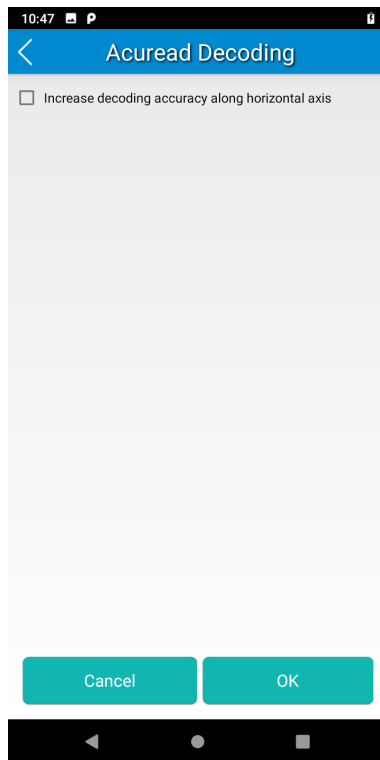
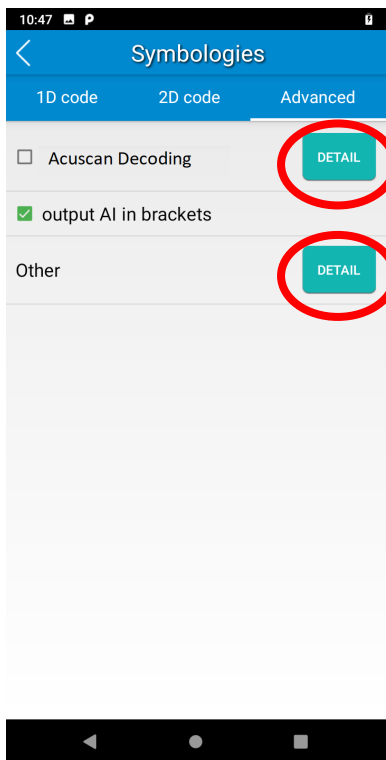

Chapter 5 Bluetooth

This chapter describes how to connect the NFT10 to other Bluetooth devices.

You can set up a Bluetooth connection between the NFT10 and other Bluetooth devices, such as PC, mobile phone. Note that the Bluetooth connection works better if there are no obstacles between them.

Before you can use a Bluetooth device with the NFT10, you must first pair them.

1. Make the Bluetooth device visible to the NFT10.
2. Tap the app icon  then “Connected devices” -> “Connection preferences” -> “Bluetooth”, and turn Bluetooth on to search for available Bluetooth devices.
3. Select the device from the search results to pair.
4. If prompted, input the pairing code and then tap “OK”; or if the pairing code is given automatically, then tap “PAIR”.

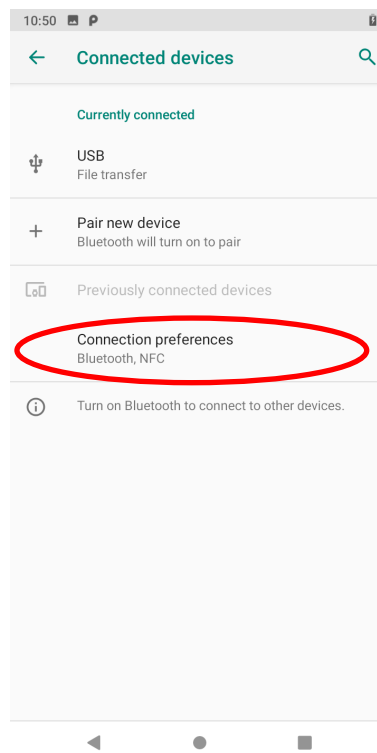
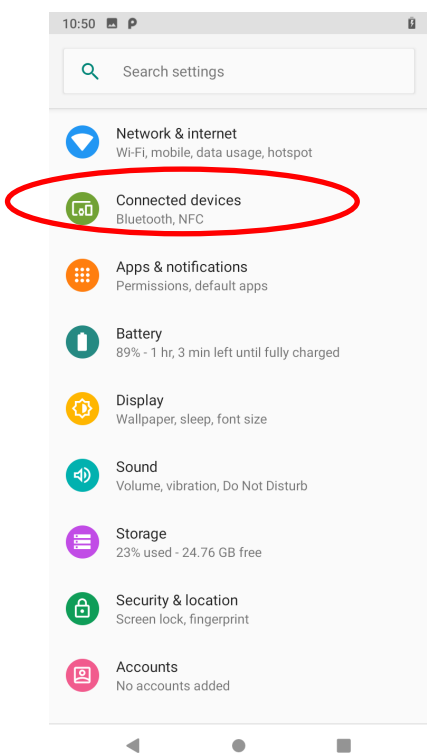

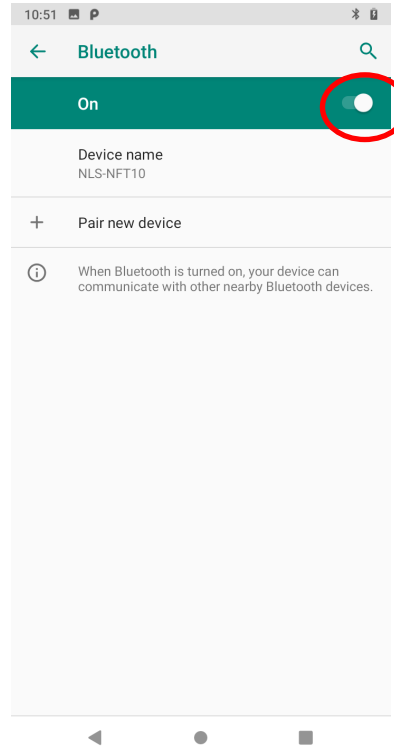
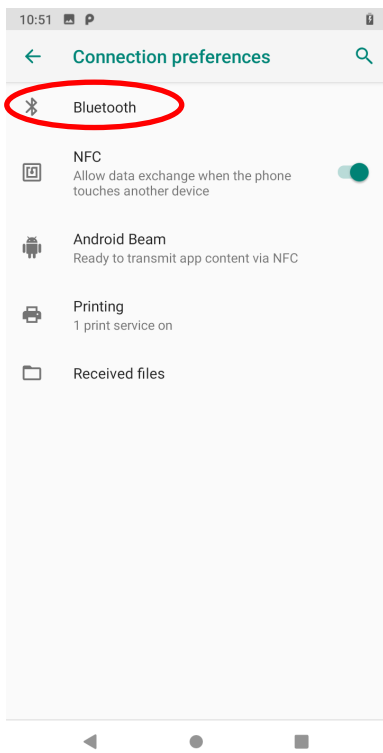

Unpair/rename a paired Bluetooth device: To rename the paired Bluetooth device, edit its name manually and then tap “OK”. To unpair it, tap “FORGET”.

Chapter 6 Wi-Fi

Introduction

This chapter describes how to connect the NFT10 to a Wi-Fi network.

Wi-Fi Settings

Join a Wi-Fi network:

1. Tap the app icon  then “Network & Internet” -> “Wi-Fi”, and turn Wi-Fi on to find available Wi-Fi networks. If Wi-Fi is already ON, then the terminal will automatically search for available networks.
2. Tap a network and then enter the password.
3. Tap “CONNECT”.

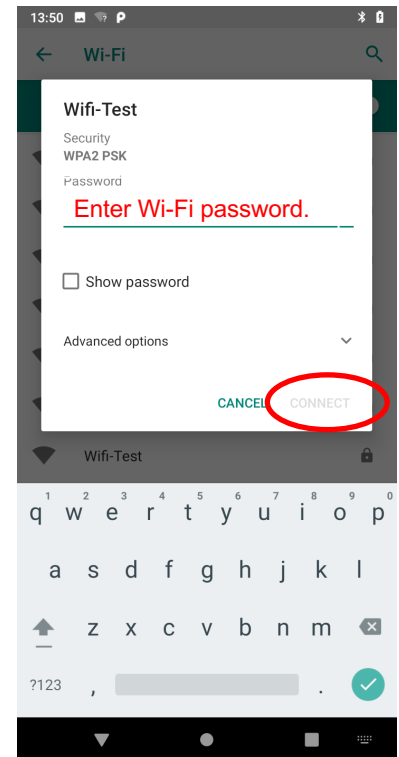
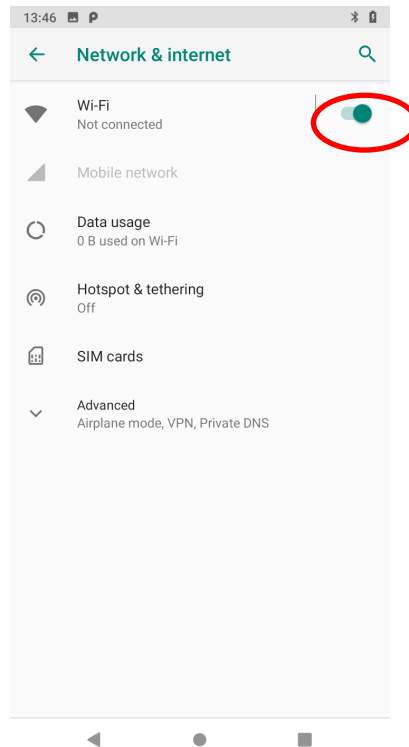
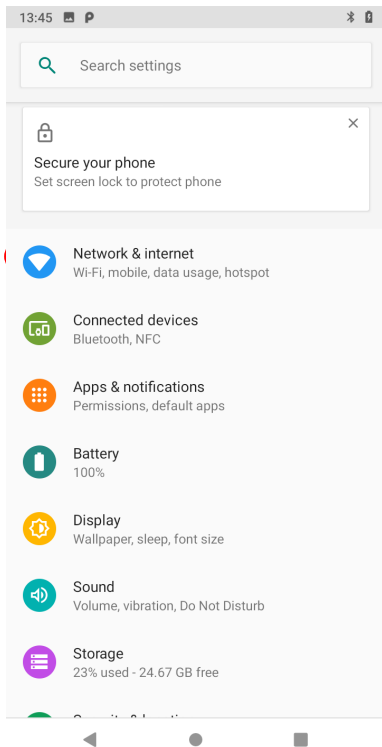

IP Settings

To set the IP, follow the first two steps of joining a Wi-Fi network, tap “Advanced options” then “DHCP”, and select the desired option.

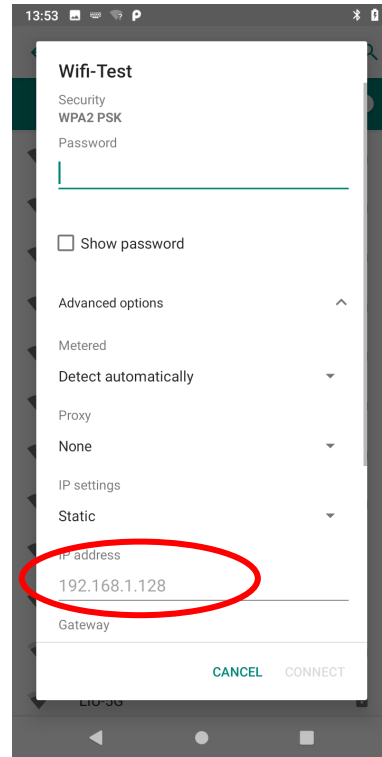
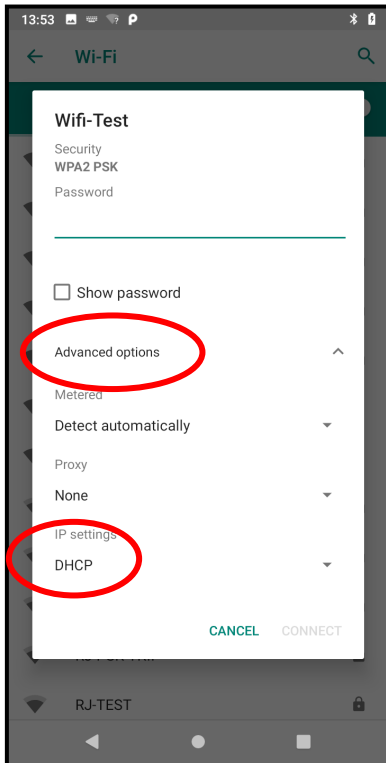

Chapter 7 Mobile Network

Introduction

The NFT10 can also use a 4G network to connect to the internet. To establish a 4G connection, you must have a SIM card installed in your NFT10.

This terminal can support 4G/3G/2G network provided by Telecom, Unicom or Mobile

Mobile Network Settings

If no Wi-Fi networks are available, or if you have turned Wi-Fi off, then the NFT10 connects to the Internet via your cellular data network when available.

Turn on the cellular network:

1. Swipe down from top to bottom on the home screen and it will display the drop-down mean, Find  and tap it to turn Cellular data on.
2. Or Go to Settings-> "Network & Internet" -> "Mobile network" -> turn on "Mobile data"

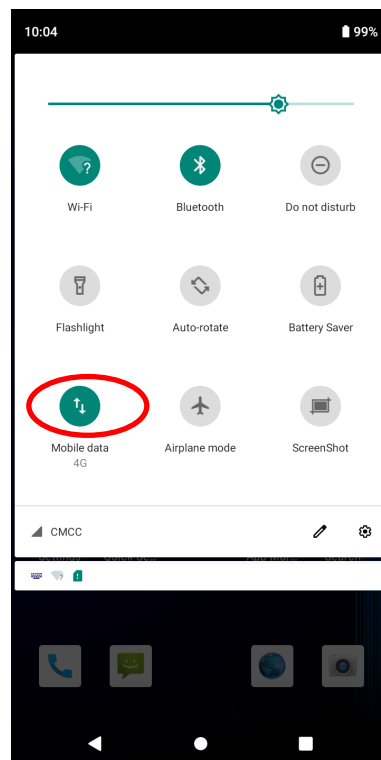
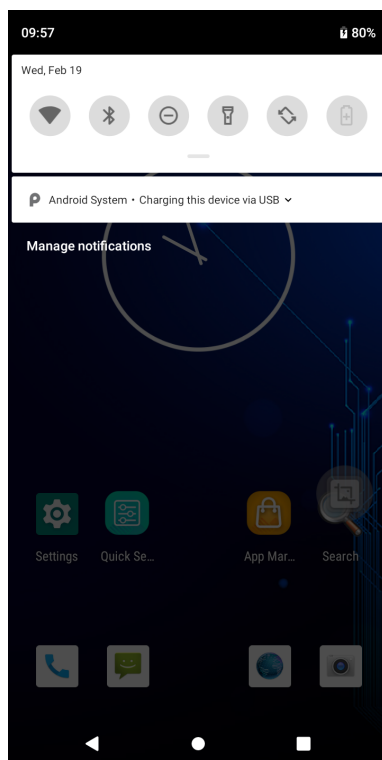

Option Two:

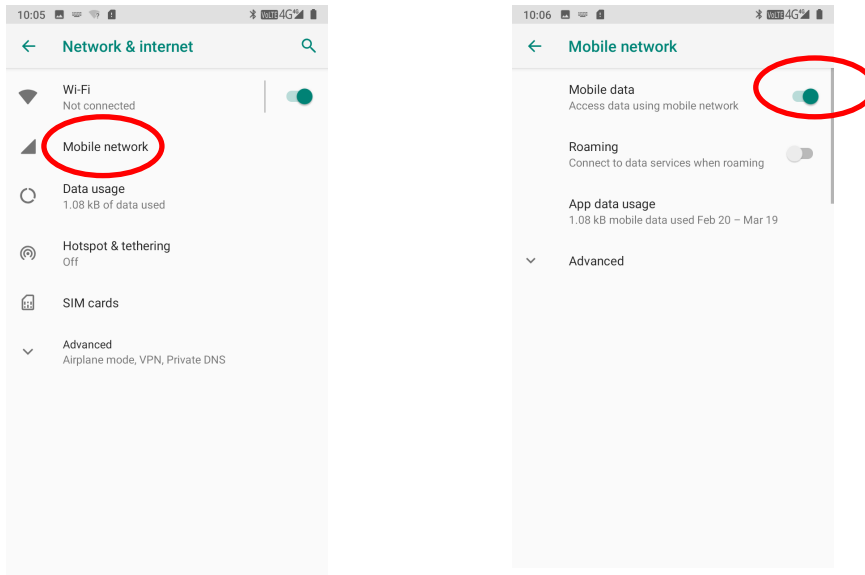

APN Settings

If you cannot connect to the internet when using your terminal's cellular data, you may need to change your APN settings on the NFT10 to fix it:

1. Go to Settings -> "Network & Internet" -> "Mobile network" -> "Access Point Names".

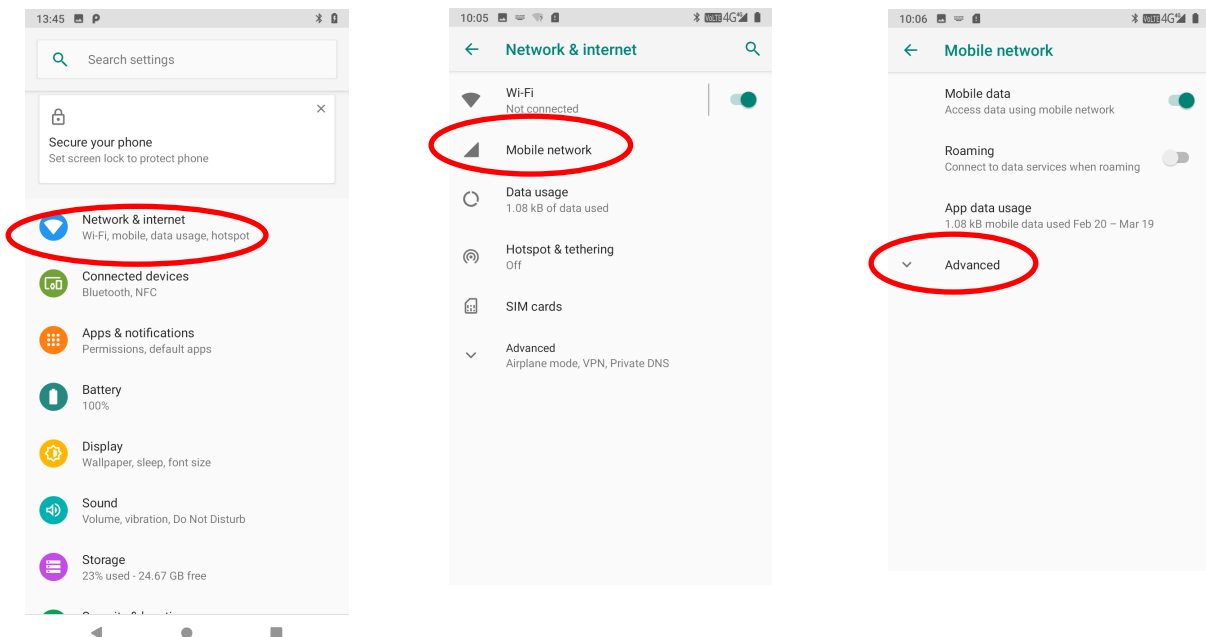

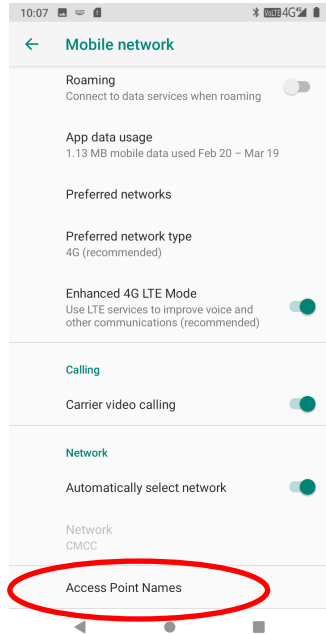

2. Tap **+** in the top right corner of the screen or tap the carrier of your SIM card on the screen. Then manually enter the APN settings. You can contact your carrier or visit their website to get the correct APN settings, or check the APN settings on a mobile device that can access the internet using the SIM card.

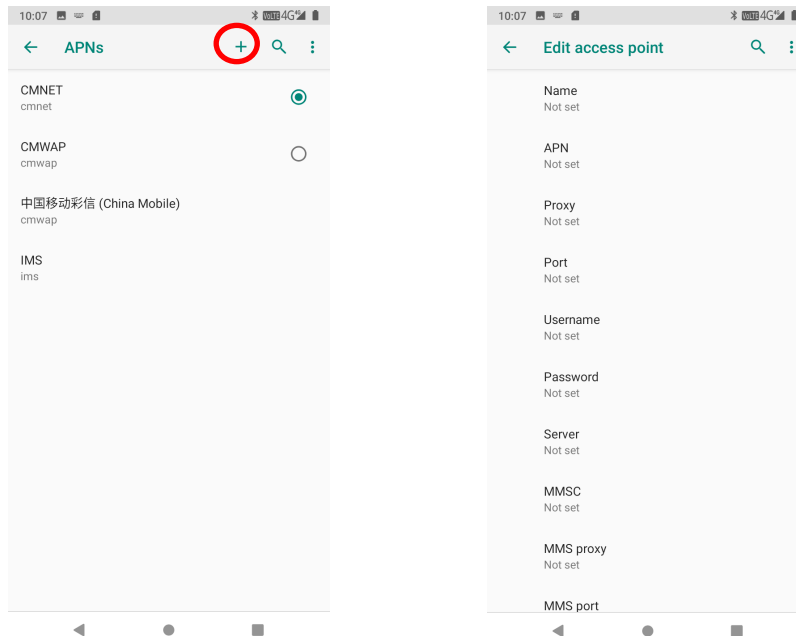



3. Press the Return key on the NFT10 to go back to the previous screen and then select the APN you just added.

Chapter 8 Others

Camera

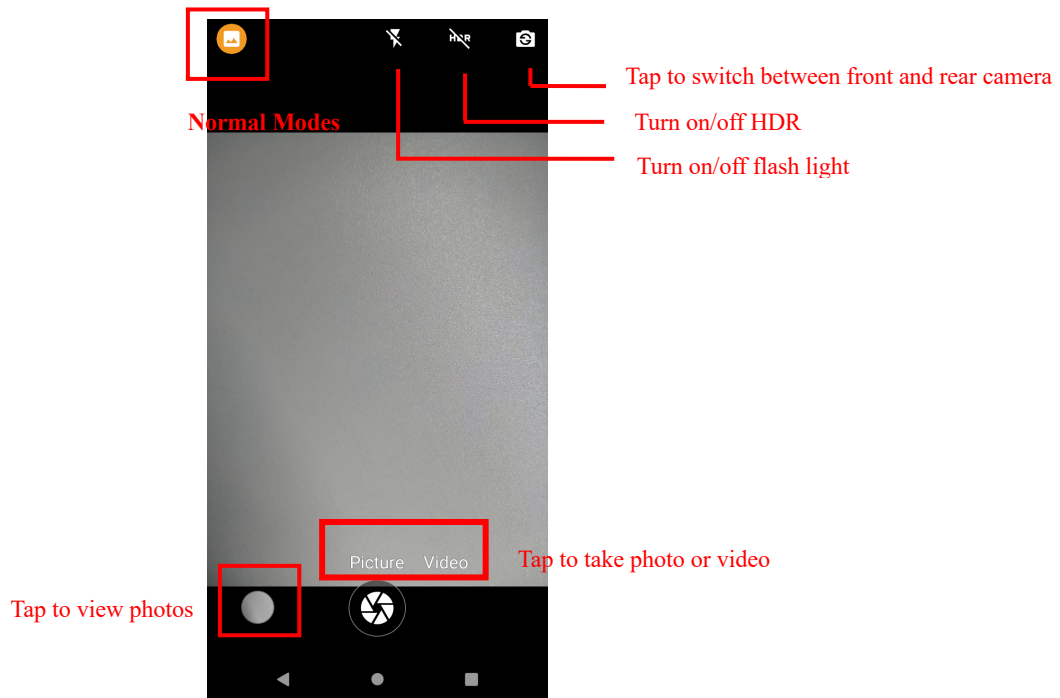
Tap the app icon  to launch the Camera app.



Tap normal modes icon  > Tap settings , then the user can set parameters such as scene mode, anti-shake, self timer, picture size, ZSD, white balance, etc.

You can also download a camera app from the internet or develop an app for the camera feature.

GPS

Tap the app icon  then "Security & location" -> "Location", and then turn Location on.

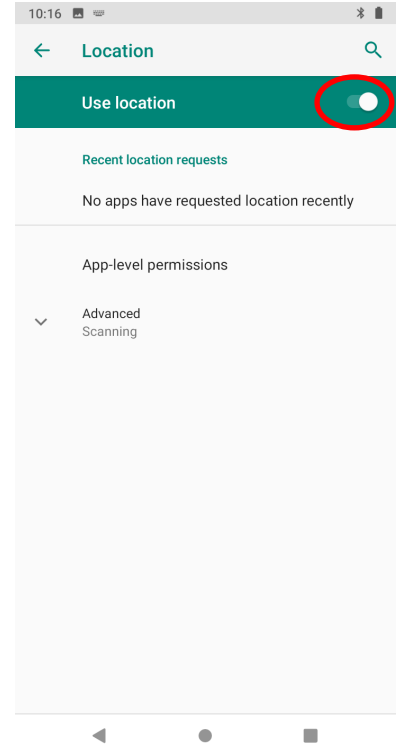
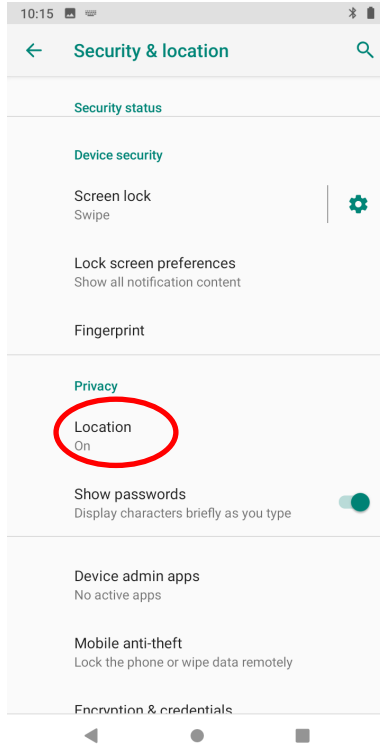
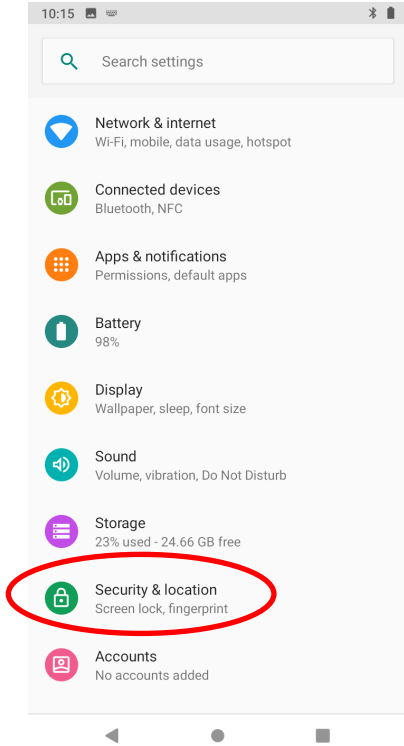

NFC

To enable the NFC feature, tap the app icon  -> "Connected devices" -> "Connection preferences" -> "NFC", and then turn on NFC.

Then you can install an NFC writer on the NFT10 to read and write NFC tags.

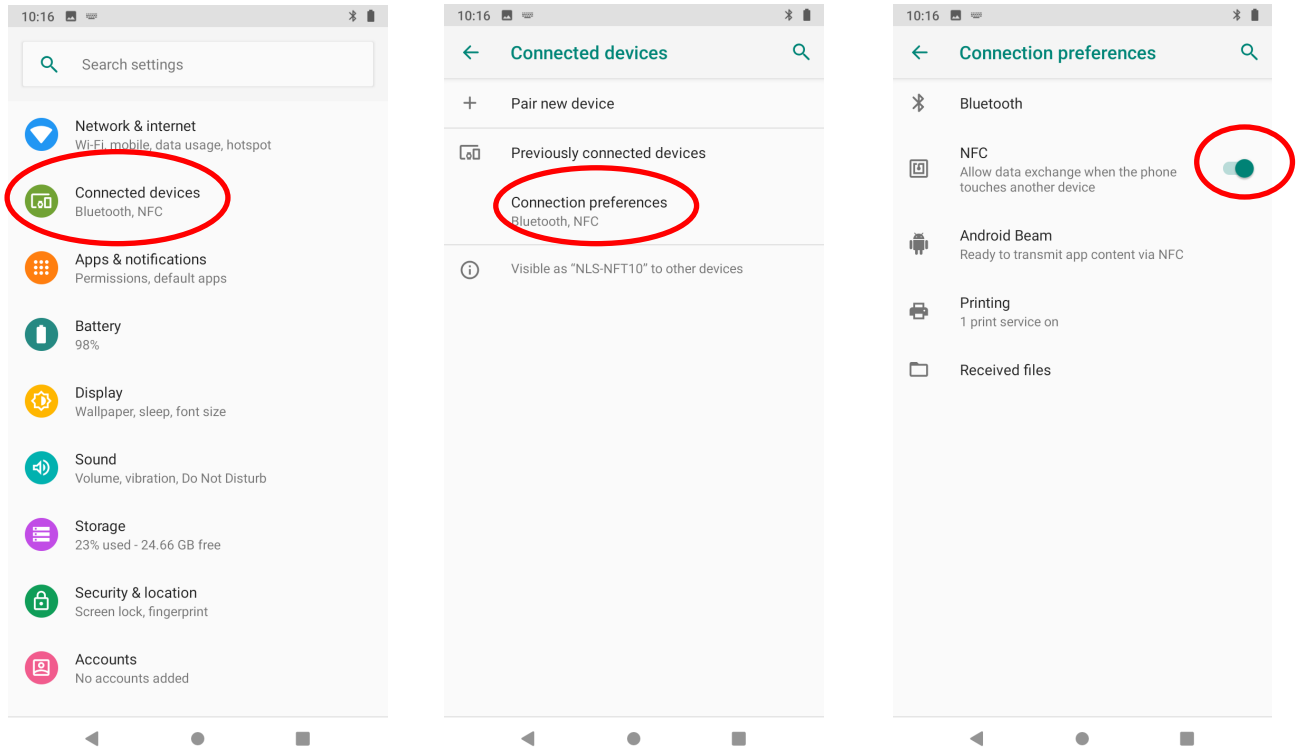

Key Map

This app allows you to remap the keys on the terminal to function as a different key or to make them into shortcuts to launch an application.

Start the Key map app: Swipe up from the bottom of the screen to view all the apps. Then tap the icon  to start the key map app.

Remap a key to another key(or app): After starting the Key map app, select the key you want to remap, and then tap “keys” and select/enter the key (or tap “apps” and select the app) to which you want to remap it.

When remapping a key to “Pop up soft keyboard”, pressing the remapped key can open/close the on-screen keyboard.

Clear All Remap: Clear all remap to return to default settings.

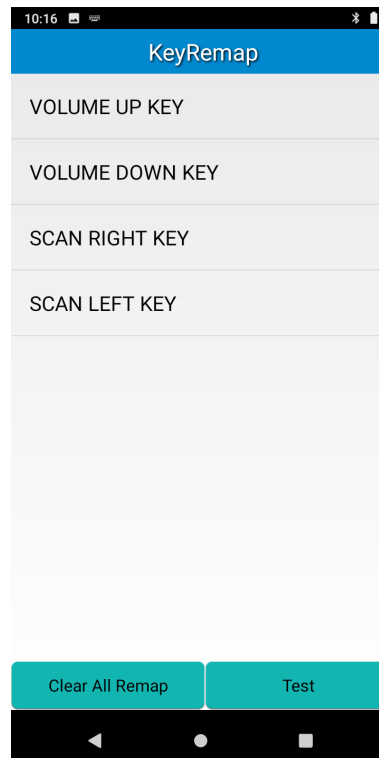
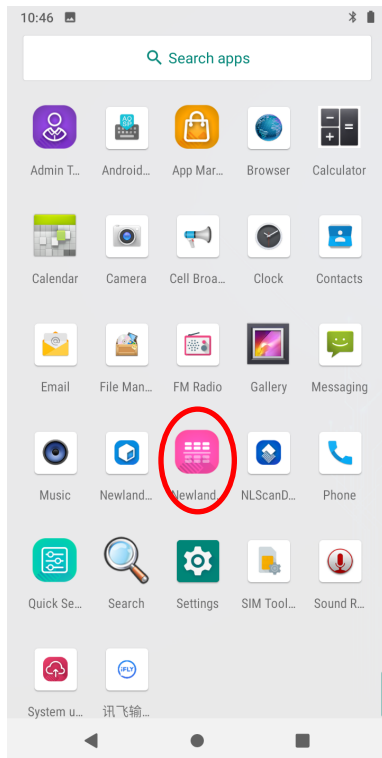

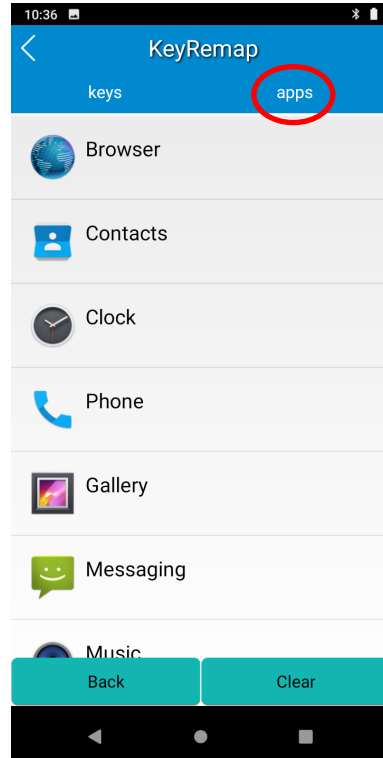
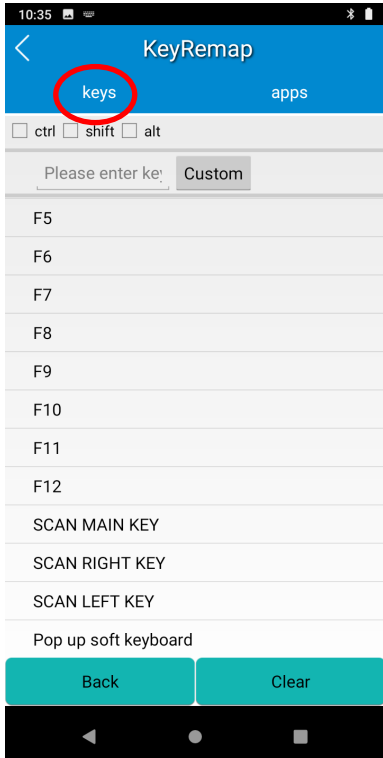

Chapter 9 Admin Tool

Introduction

The Admin Tool app is used to specify the apps that users can run on the NFT10.

Launching the Admin Tool

Tap the app icon  to launch the admin tool and enter the User mode. Tap the “Back Button” on the screen and then enter the password (default: 112233).

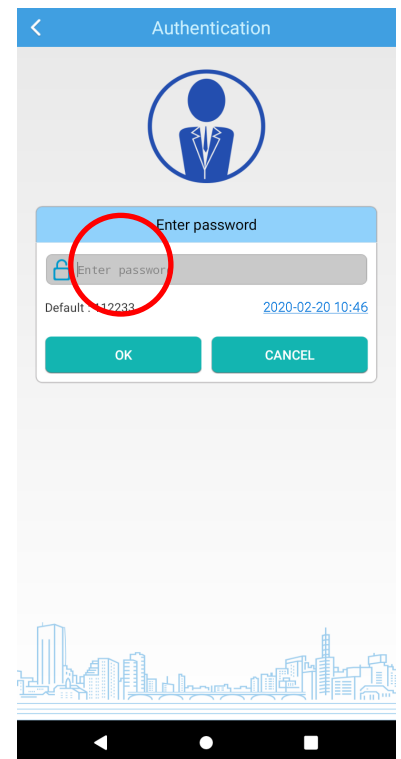
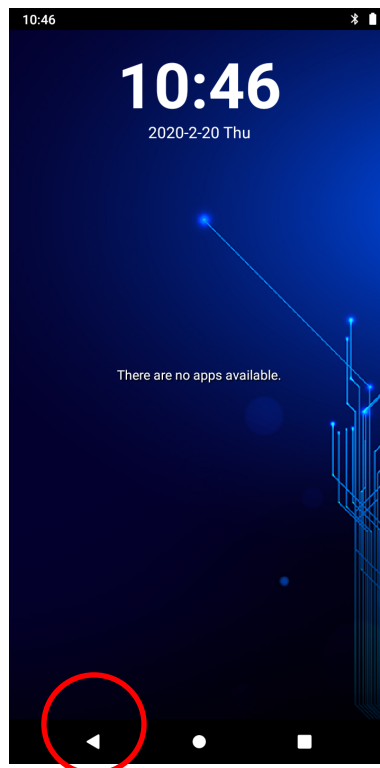
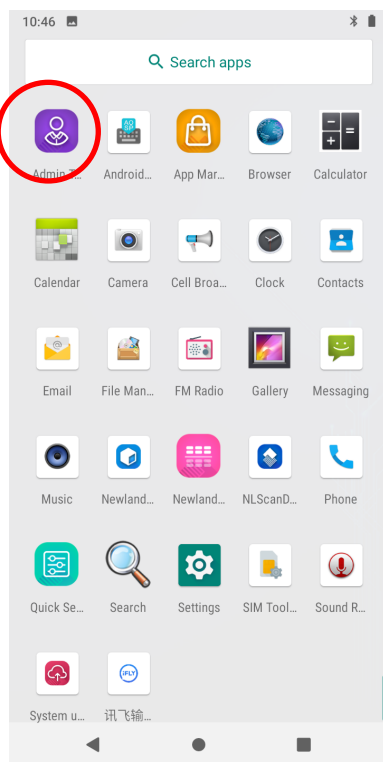

When in the Admin mode, you may set the following parameters as per your actual needs.

1. App Manager: Tap “App Manager” -> “Select App”, then select or deselect the apps available to normal users.

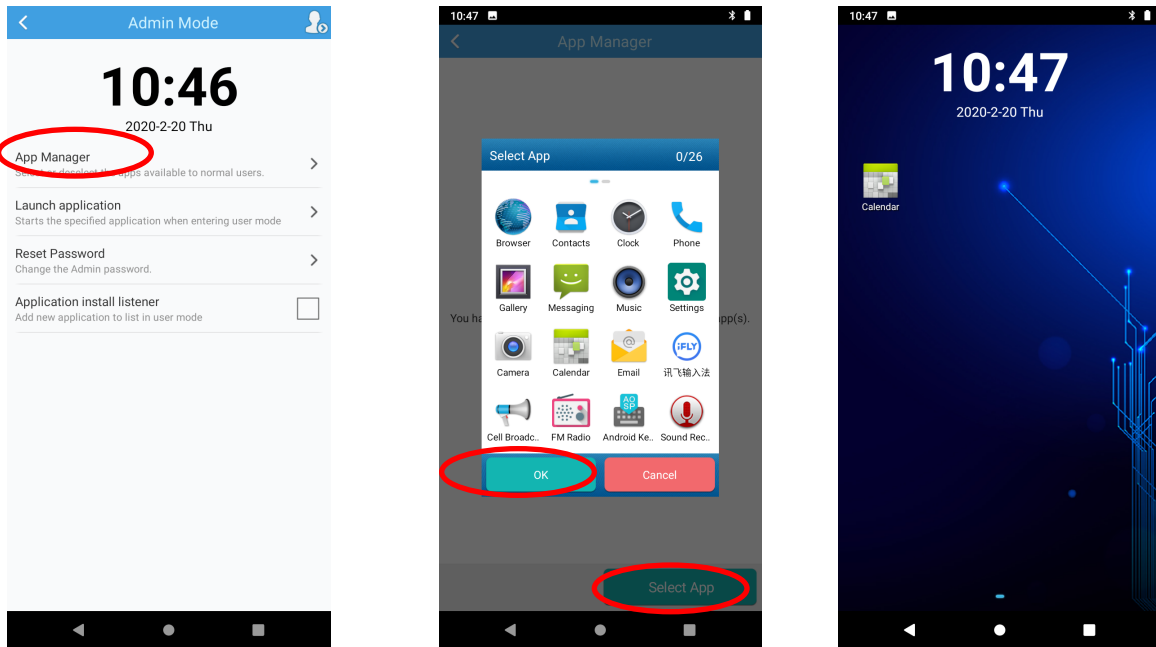

2. Reset Password: Change the Admin password.

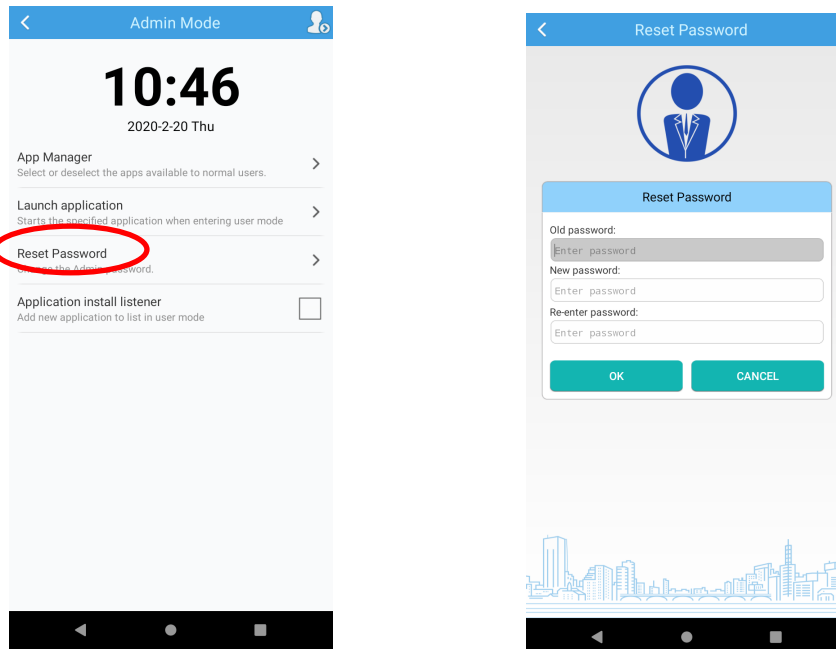

Switching between User Mode and Admin Mode

Enter User Mode: To switch from the Admin mode to the User mode, tap in the top right corner of the screen.

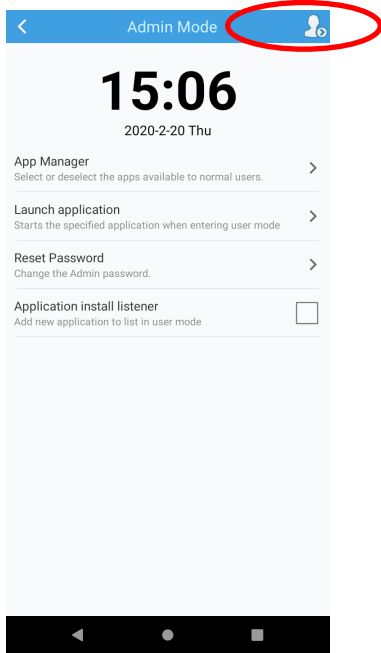

Exit User Mode: Press the Back Button on the NFT10 and then enter the password (default: 112233).

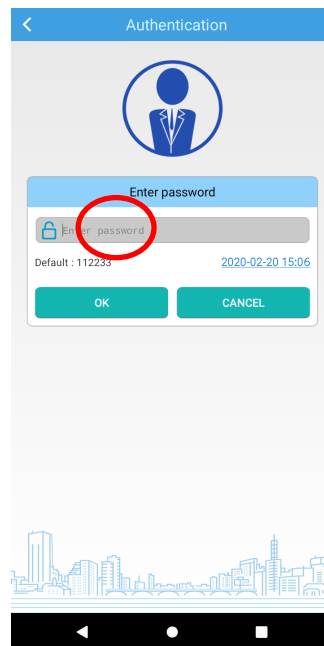
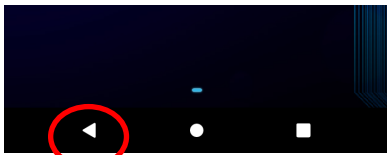



Chapter 10 Whitelist Manager

Introduction

The Whitelist Manager app is used to specify the apps that users can install on the NFT10.

Logging in to Whitelist Manager

Tap the app icon  on the Home screen then , enter the password (default: 112233), and tap “Login” to log in to the whitelist manager. Then set up your whitelist as per actual needs.

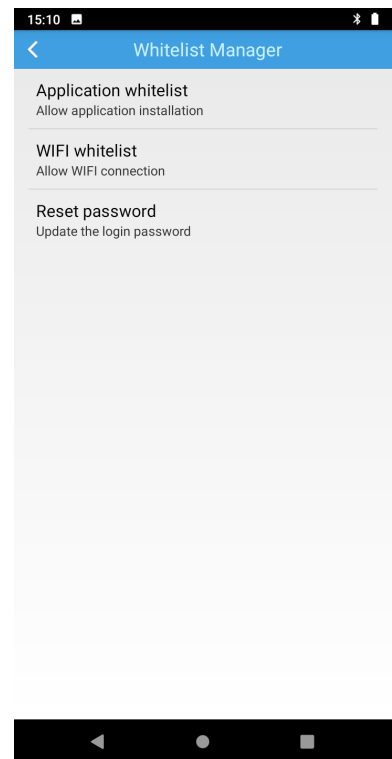
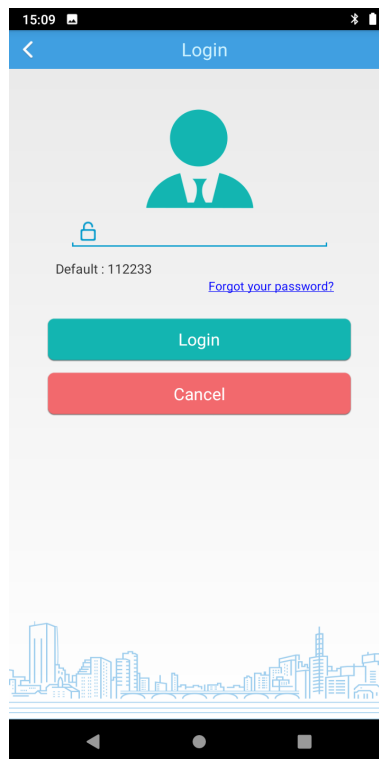
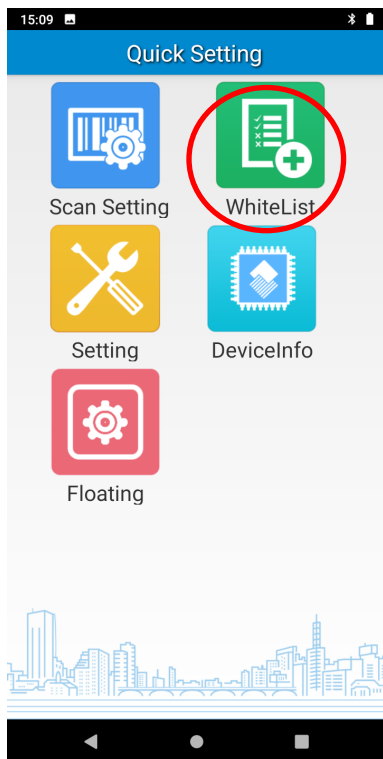

Chapter 11 System Update

Introduction

This chapter introduces two methods to update the system software of the terminal: Online update and local update.

Online Update

Update the system online: Tap system updates icon  -> "CHECK FOR UPDATES".

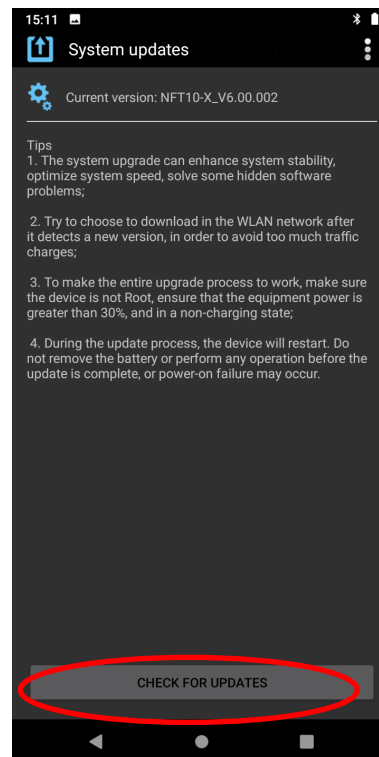
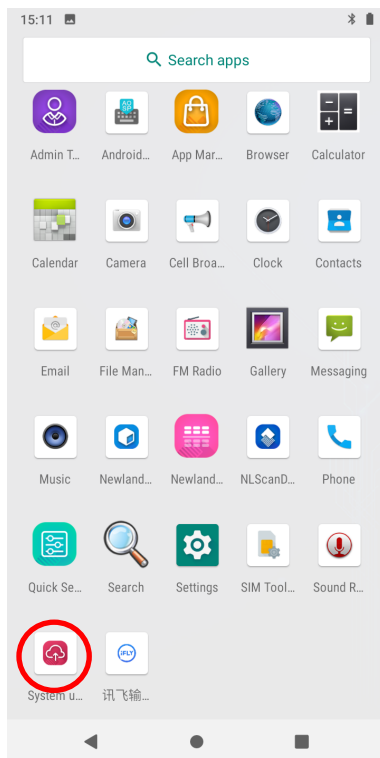

Local Update

Zip File to the NFT10 Drive

1. Connect the terminal to PC with the included USB cable. Swipe down from top to bottom with one finger in one smooth motion to open the notification bar. Tap "USB for file transfer". Then select "Transfer files".

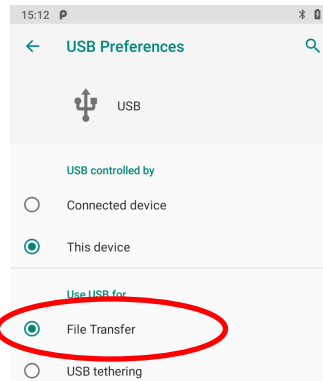
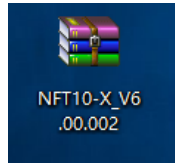

2. Copy the update zip file to the NFT10 drive or NFT10's Micro SD card.

3. Tap  to access the System Update screen.

4. Tap  in the top right corner of the System Update screen then select "Local Update".

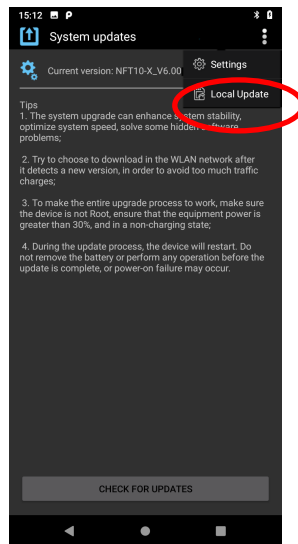

5. Select the update zip file. Then select "NEXTREBOOT" or "UPDATE".

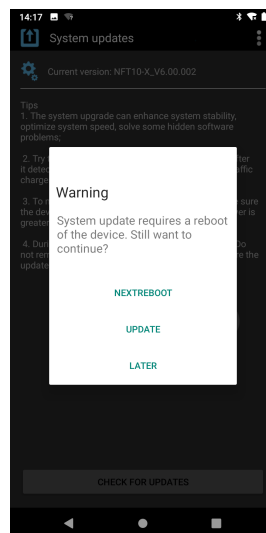
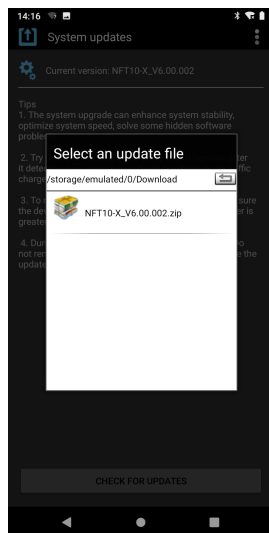

Zip File to TF Card

1. Copy the update zip file to TF Card.

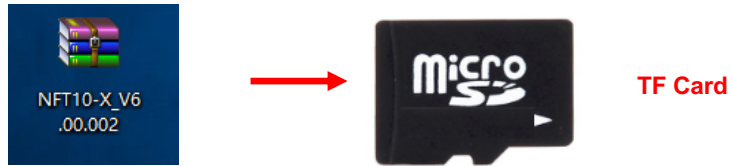

2. Insert the TF card to the NFT10 and then power on the terminal.

3. Tap  to access the System Update screen.

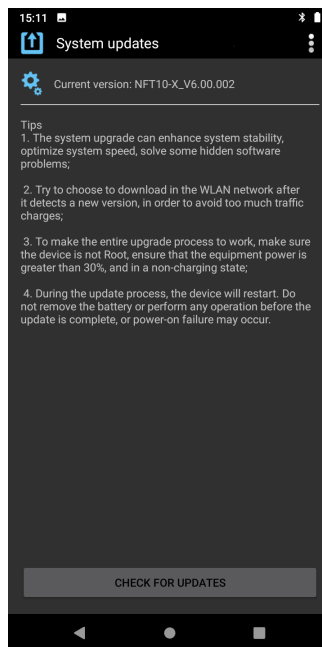

3. Tap  in the top right corner of the System Update screen, and then select “Local Update” -> “External Storage”.

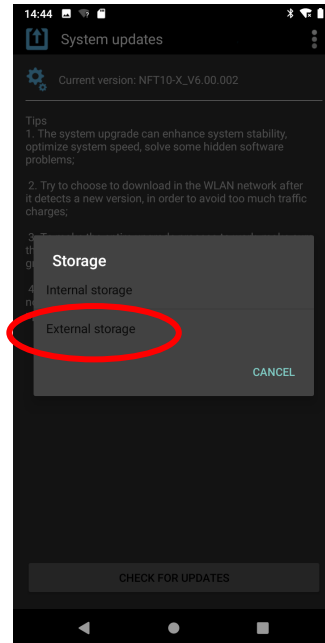
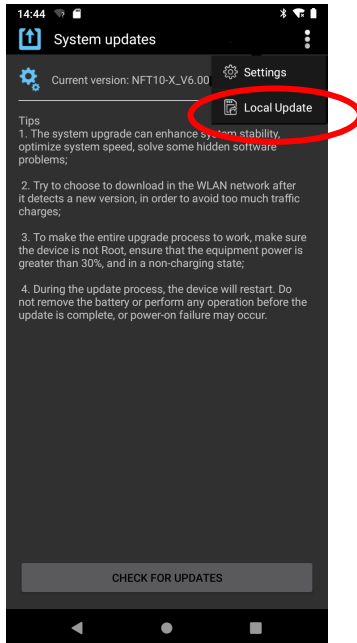

2. Select the update zip file. Then select “NEXTREBOOT” or “UPDATE”.

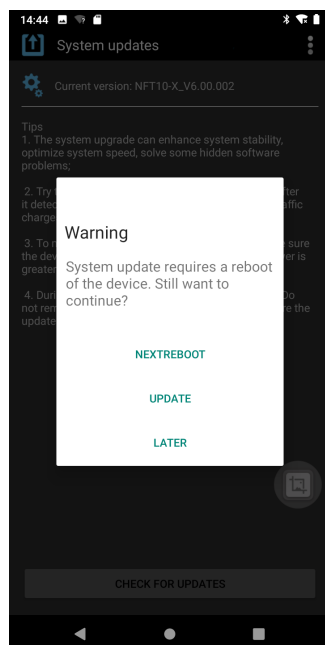
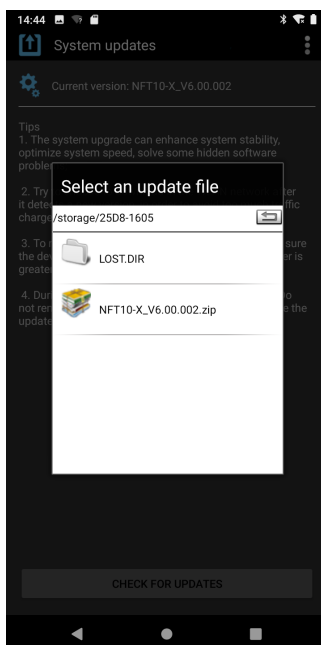

Chapter 12 App Development Guide

Development Environment

The NFT10 runs on the Android 9 operating system, so you should use Android SDK 9 or lower when developing apps for the NFT10.

Use of Non-standard Interfaces

See *Newland Android PDA API Handbook*.

Chapter 13 Maintenance & Troubleshooting

Introduction

This chapter includes important safety and handling information and provides troubleshooting solutions for issues that might occur when using the terminal.

Important Safety & Handling Information

Disassembly and Retrofit

Do not attempt to disassemble or retrofit the terminal yourself. Unauthorized disassembly or retrofit will void the warranty.

External Power Supply

Use only the included AC adapter. Otherwise, there is a risk of damage to the terminal.

Abnormal Situation

Keep the terminal away from fire or heat sources. If there is unusual odor, overheating or smoke during charging, immediately cut off the power and disconnect the AC adapter, and contact your dealer or Newland customer service center. Continued use in this case may result in fire or electric shock.

Drop Damage

If the terminal is damaged due to a drop from a high place, immediately cut off the power and contact your dealer or Newland after-sales service center.

LCD Screen

Do not press against or strike the LCD screen. Otherwise, it may damage the screen. When handling a cracked or shattered screen, do not touch the liquid that has leaked from it to avoid skin burn or infection.

Stacking Heavy Objects

Do not place heavy objects on the terminal as those objects may fall and cause injury.

Mounting Location

Do not place the terminal on unstable or uneven surfaces as it may fall and cause injury. Do not expose the terminal to humidity or dust as this may cause fire or electric shock. Do not expose the terminal to direct sunlight for extended periods.

Wireless Functionalities

Do not use the terminal's wireless functionalities where wireless device use is prohibited or where it may cause interference or danger, such as in aircrafts, petrol stations.

Use & Maintenance

- ✧ Do not use damaged or faulty AC adapters.
- ✧ Do not dispose of terminals in a fire as they may explode.
- ✧ Do not continue to charge a battery that is fully charged. Overcharging will shorten battery lifespan.
- ✧ If the terminal cannot be switched on after experiencing a sudden or unexpected power loss or other abnormalities, immediately contact your dealer or Newland after-sales service center
- ✧ Do not throw, drop, or strike the terminal. Doing so may damage the LCD display, interrupt running programs, cause data loss in memory, and result in malfunction.
- ✧ Clean the scan window regularly. Do not touch it with hands. Scratched or smudged window may degrade reading performance.
- ✧ Do not tap the touch screen with sharp objects. Doing so may damage the screen or cause internal short circuits.
- ✧ Use only dry soft cloth to clean the terminal. Cleaning it with a wet cloth or benzene/ thinner/ other volatile chemicals may deform and shorten the service life of the terminal's shell.
- ✧ Sudden temperature drops may cause condensation on the shell, which could cause malfunction. Care should be taken to avoid condensation. If condensation occurs, dry the terminal before use.
- ✧ Properly dispose of and recycle terminals. Do not dispose of them as household garbage.

Troubleshooting

Problem		Possible Cause & Solution
Type	Description	
Battery	Charging LED is OFF when charging.	Ensure the AC adapter is plugged in properly.
	Noticeably short battery life.	<ol style="list-style-type: none"> 1. Check the battery level. If the battery is almost depleted, recharge it. 2. Restart the terminal, if the problem remains, please contact the after-sales service center.
	Fully charged battery is depleted after the terminal is switched on.	Restart the terminal, if the problem remains, please contact the after-sales service center.
USB	USB communication failure	<ol style="list-style-type: none"> 1. Ensure that the USB cable connections are secure. 2. Ensure that there is no contaminant inside the USB port. 3. If the problem remains, please contact the after-sales service center.
LCD Screen	No display	<ol style="list-style-type: none"> 1. Ensure the terminal is switched on. 2. If the terminal is in sleep mode, press the Power key to wake it up. 3. Check the battery level. If the battery is depleted, recharge it. 4. If the problem remains, please contact the after-sales service center.
System	Cannot switch on	<ol style="list-style-type: none"> 1. Check the battery level. If the battery is depleted, recharge it. 2. Switch the terminal on after using the included AC adapter to connect it to a power outlet. If the problem disappears, then continue to charge the terminal. If the problem remains after charging the terminal for a while, please contact the after-sales service center.
	System halted	<ol style="list-style-type: none"> 1. The problem may be caused by bugs on downloaded apps. Ensure that only reliable apps are used. 2. The problem may be caused by a sudden or unexpected power loss. Long press the power key for 10 seconds, and then restart the terminal. 3. If the problem remains, please contact the after-sales service center.



Newland EMEA HQ

+31 (0) 345 87 00 33
info@newland-id.com
newland-id.com

D-A-CH

0049 (0) 6182 82916-16
info@newland-id.de

United Kingdom

+44 (0) 7771 631387
sales@newland-id.co.uk

France

+39 (0) 345 8804096
france@newland-id.com

Russia

+31 (0) 345 87 00 33
russia@newland-id.com

Benelux

+31 (0) 345 87 00 33
benelux@newland-id.com

South Africa

Gauteng: +27 (0) 11 553 8010
Cape Town: +27 (0) 21 9140819
info@newland-id.co.za

Ibérica

+34 (0) 93 303 74 66
info@newland-id.es

Middle East

+39 (0) 345 8804096
middleeast@newland-id.com

Italy

+39 (0) 342 0562227
italy@newland-id.com

Turkey

+90 (0) 544 538 40 49
turkey@newland-id.com

Nordic & Baltic

+46 (0) 70 88 47 767
nordic@newland-id.com